



INGLIS RIVER WALKING TRAIL

Options Study

29 August 2023

Contents

1	Introduction	p. 1	5	Track improvement projects	p. 22
	Background Project aims and objectives Study area Methodology			Improvement project 1 Improvement project 2 Improvement project 3 Improvement project 4 Improvement project 5 Typical details	
2	People	p. 4	6	Analysis of projects	p. 33
	Demographic context Public use of the track			Criteria and weighting Multi-criteria analysis results Recommendations	
3	Site analysis	p. 7	7	Implementation	p. 35
	Site observations Environmental values Cultural heritage values Erosion and landslip Sea level rise and storm tide Statutory context Track and structures condition			Indicative costs and hierarchy General recommendations	
4	Issues and opportunities	p. 20	8	Appendices	p. 40
	Issues and opportunities plan			Multi-criteria analysis Community engagement data Condition Assessment Report Cultural Heritage Report Sisters Beach Management Plan York Street Reserve Natural Values Assessment	

1 Introduction

Background

Fitzgerald Frisby Landscape Architecture, along with subconsultants Rare Innovation (structural engineering) and Cultural Heritage Management Australia (cultural heritage) has been engaged by Waratah-Wynyard Council to undertake an Options Study of the Inglis River Walking Track.

The Track meanders through the riparian reserve of the Inglis River from the bridge crossing at the Bass Highway through to the river mouth and provides a recreational connection between Gutteridge Gardens and Fossil Bluff. Over time a number of timber structures and hardened paths have been constructed through this walkway to support its use and growth. Some of these structures are now at the end of their useful lives and require replacement with replacement cost estimated by Council to be approximately \$1.8m. In 2011 and 2016 significant flood damage was incurred to the walking track infrastructure as well as noticeable erosion and loss of some of the riverbank.

Given the relatively high cost in replacing the structures, Council seeks to gain an understanding and appreciation of whether the current walking track structures and alignment are fit for purposes or require upgrade/relocation or augmentation as part of the replacement program.

Project aims and objectives

The following known issues/concerns have been highlighted by Council for investigation by the project team:

- The majority of the structures have been recommended by Council for replacement within the next five years;
- Most structures are not built to current day standards in terms of width and grade and there isn't a designated track grading for consistency in accordance with AS 2156.1;
- Some of the structures are subject to inundation during flood events;
- There are visual signs of erosion to the banks of the river in the vicinity of these structures;
- Some structures are located in places with limited exposure to sun light causing them to become slippery;
- The Inglis River walking track is a valued asset of the community and is well utilised. The types and volume of use has likely grown since initial construction (some mountain bike use etc.).

In addressing the above the Options Study will address the following questions:

- How prevalent is the risk of susceptibility to erosion and flood and what is the long term risk to the structures in their current location;
- What is the current and likely increase in usage demand;
- What is the best material to use in replacing these structures based on cost/benefit principles;
- What width and grade needs to be allowed when replacing the structures to accommodate future use needs;
- Who are the user groups of the pathway and does the current path align with their needs and restrictions;
- What are the best plant species that both thrive in the given environmental conditions, are native to the area and that encourage natural biodiversity and wildlife sanctuary;
- Future access provisions to the various sections of walkway for the purposes of maintenance and weed control.
- What cost is associated with delivering the recommendations of the report.





Study Area

The Study Area extends along the south side of the Inglis River from Jenner Street Boat Ramp to the Bass Highway and along the north side of the river from the Bass Highway to Fossil Bluff. The trail between Gutteridge Gardens and the Jenner Street Boat Ramp was excluded from the Study.

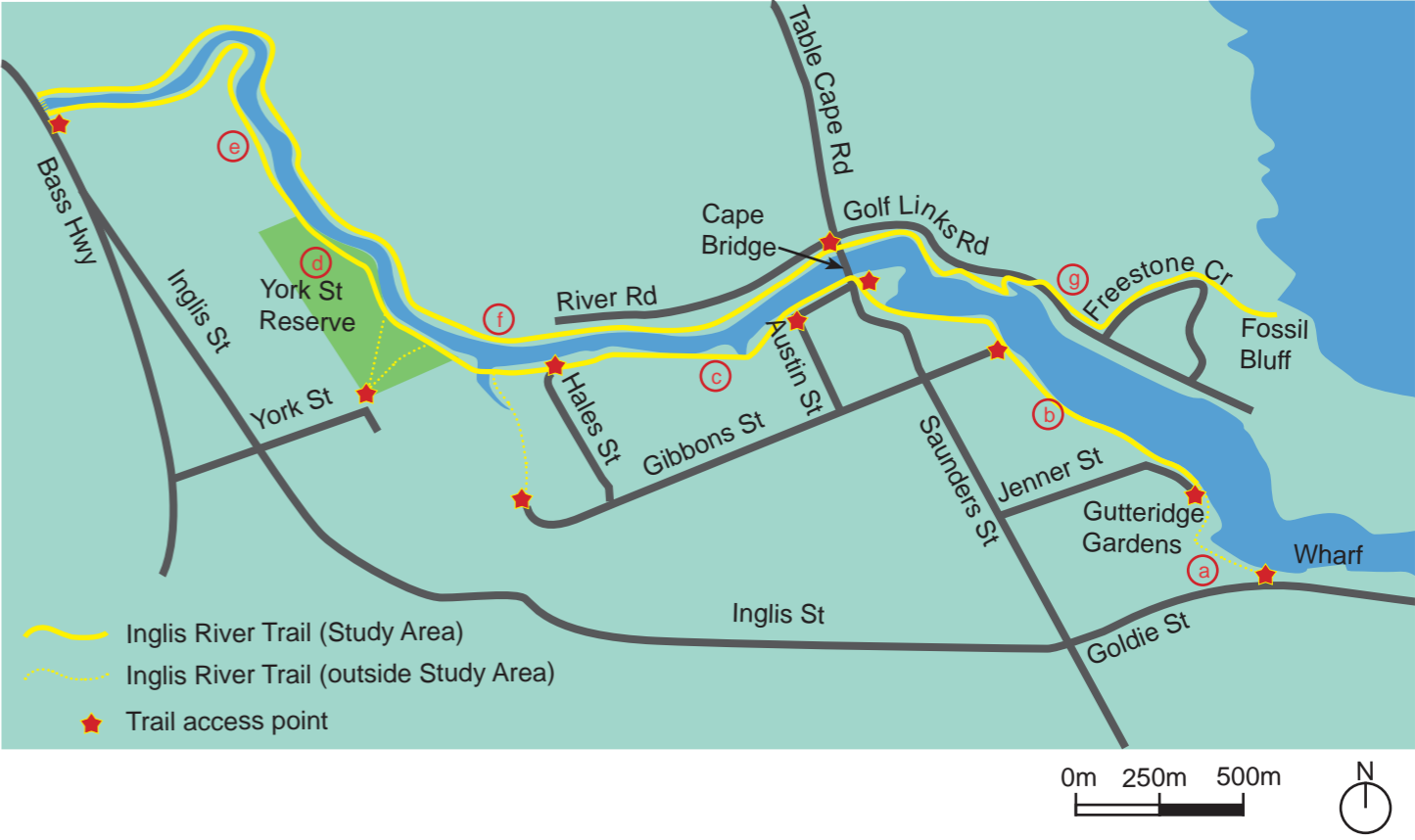

- (a) Wynyard Wharf to Jenner Street Boat Ramp
(note: this section of trail is not included in the Study Area)
- (b) Jenner Street Boat Ramp to Cape Bridge
- (c) Cape Bridge to Big Creek Bridge
- (d) Big Creek Bridge to York Street Reserve
- (e) York Street Reserve to Bass Highway Bridge
- (f) Bass Highway Bridge to Cape Bridge
- (g) Cape Bridge to Fossil Bluff



Methodology

The project was divided into two broad phases: information gathering and project analysis. The first phase included the following tasks:

- Desktop analysis and background research using sources such as the LIST and Natural Values Atlas;
- Discussions and site walks with internal Council stakeholders;
- Public and external stakeholder consultation;
- A detailed engineering assessment of existing structure and path condition;
- Review of site character and environmental values; and
- A Cultural Heritage Report.

Further details of the information gathered can be found in subsequent chapters of this Study.

Information gathered during the first phase informed the selection of five 'trail improvement projects' for further analysis and possible implementation. The intention is that implemented projects will become case studies and will inform the upgrade approach along the rest of the trail. Further details of the analysis process and the improvement projects can be found in subsequent chapters of this Study.

Based on information gathered during the first phase the Study also makes recommendations for other future projects and general improvements to be considered for implementation during routine works or improvement projects.



Image: Shells in rock at Crowes Bend

3 People

Demographic context

Except where otherwise noted, the following information has been sourced from:
<https://profile.id.com.au/tasmania>
 2019 Population Projections - DEPARTMENT OF TREASURY AND FINANCE

Population change

The resident population of Waratah-Wynyard in 2021 was 14,307. Although between 2016 and 2021 it grew by almost 6%, the population of the LGA is expected to decrease by approximately 1,956 persons over the period to 2042.

In 2021, the dominant age group in Waratah-Wynyard was persons aged 50 and above, which accounted for over 47% of the total population. This age group also accounted for 92.8% of the LGA's population growth between 2016 and 2021. Babies and pre-schoolers (ages 0-4) made up almost 5% of the population, primary and secondary school-aged children accounted for 15%, while adults aged 18-49 made up about 32% of the population.

The ageing profile of the community will influence leisure participation demands. Demand for informal, non-club based leisure opportunities can be expected to increase associated with the physical activity participation preferences of an ageing community (e.g. including walking and social gathering).

It is worth noting that at the time of this study residential subdivisions were being developed within the immediate catchment of the Study Area. It is also reasonable to expect that although the population of Waratah-Wynyard as a whole is projected to decrease the township itself, where the Study Area is located, may see population increase over the same period as aging residents seek to live nearer to the facilities it provides.

Disability

Disability impacts a significant percentage of the population. The Australian Bureau of Statistics Disability, Aging & Carers, Australia 2018 report found that 17.7% of the Australian population reported having a disability (with disability defined as 'any limitation, restriction or impairment which restricts everyday activities and has lasted, or is likely to last, for at least six months'). 5.7% of Australians reported having either a profound or severe disability, requiring assistance or having difficulty with core day to day tasks. It also found that the prevalence of disability increases with age - almost half (49.6%) of people aged over 65 years old experienced disability.

Almost one-quarter (23.2%) of all people with a disability reported a mental or behavioural disorder as their main condition. Physical activity has been shown to benefit mental health.

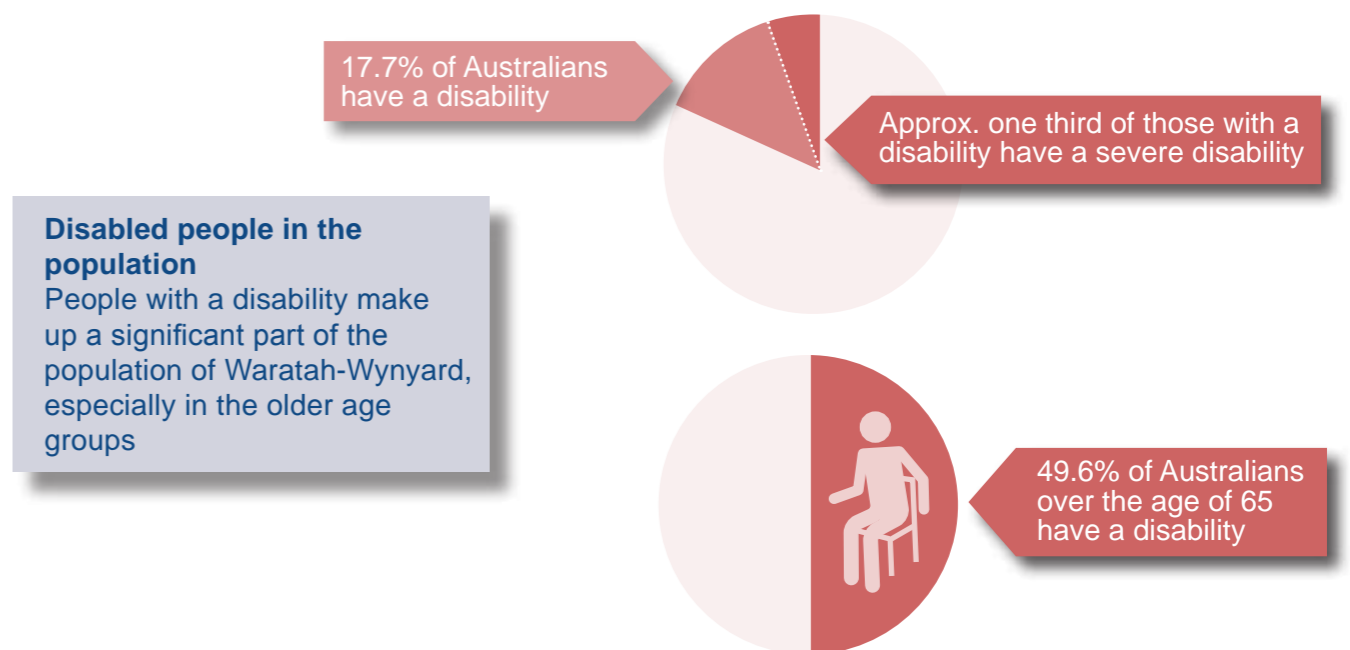
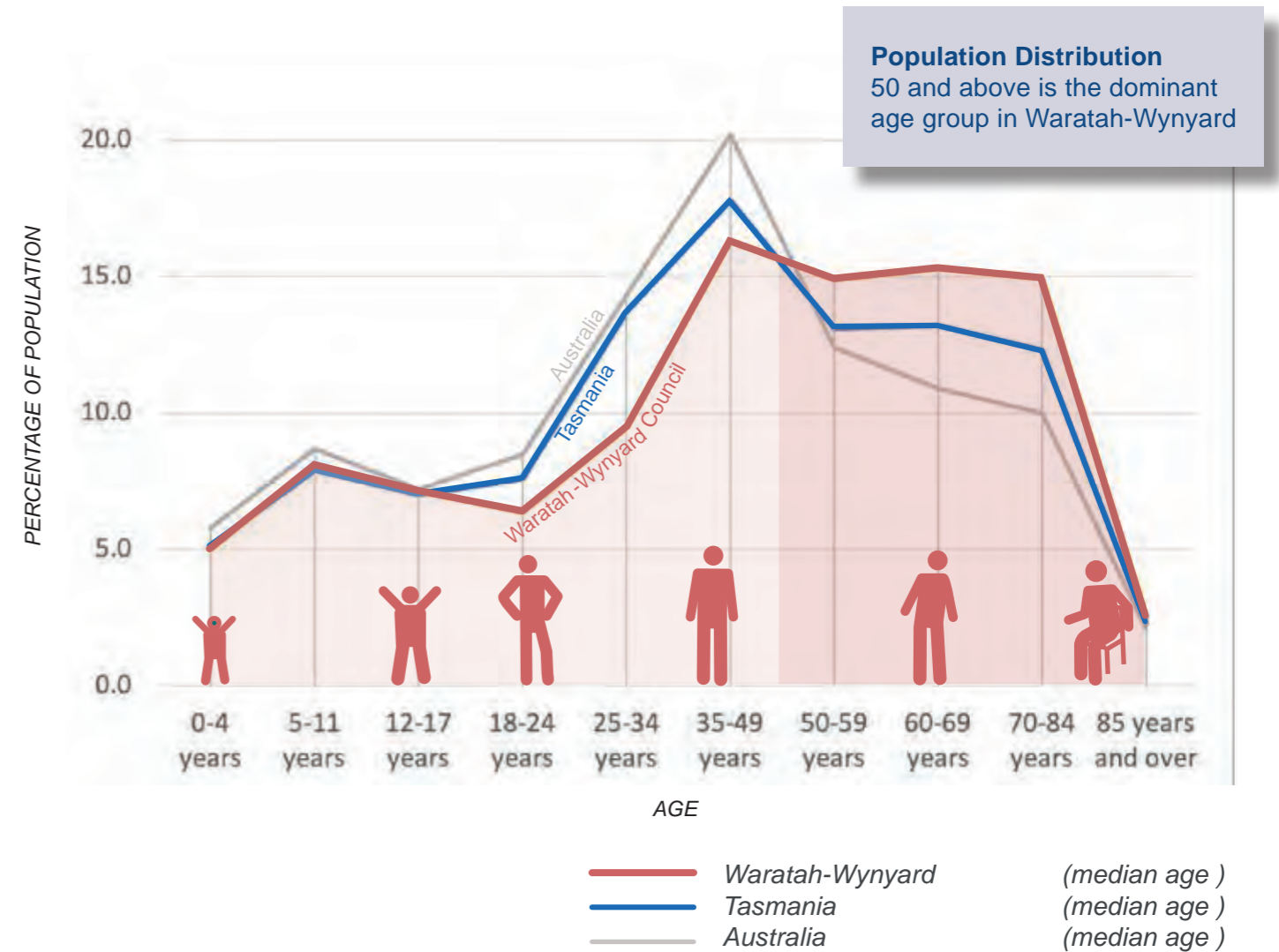

Public use of the track

Public engagement

In addition to meetings with representatives from local community groups, community engagement was undertaken to assist the project team in understanding current use patterns and community attitudes regarding the track and to identify issues and opportunities.

Public engagement comprised:

- An online survey on Council’s website. The survey was open for two weeks during November-December 2022 and received 74 responses.
- Two on-site engagement events at Gutteridge Gardens (Friday 2 and Saturday 3 December), with a total of about 20 attendees.

Gone Nuts adventure run

In addition to use by the public the Track forms part of the annual Gone Nuts adventure running course which begins in Stanley. Comment was sought from the organisers.

Landcare

The local landcare group undertakes projects along the trail and provided a submission to the project team.

Responses to the survey and results of the on-site engagement events are summarised below. Refer to Appendix for full consultation data.

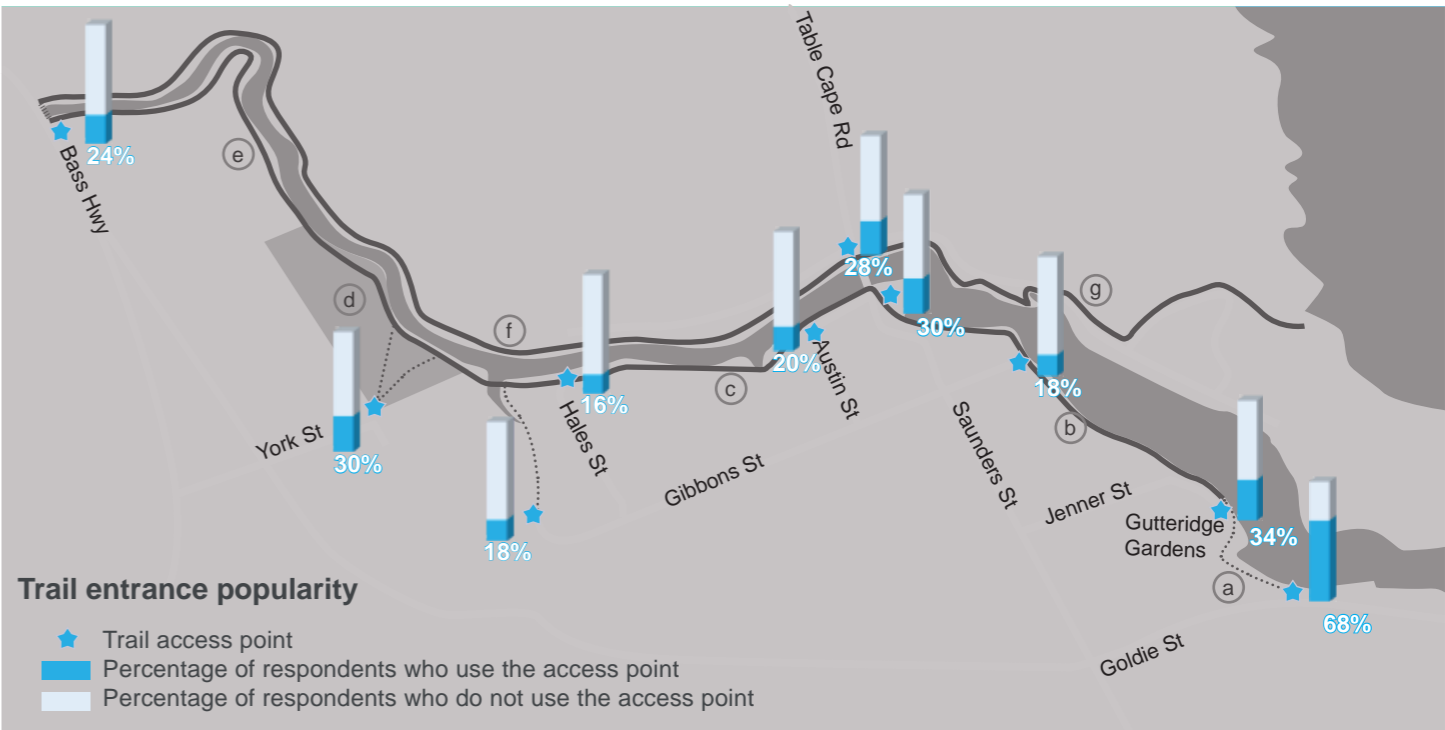
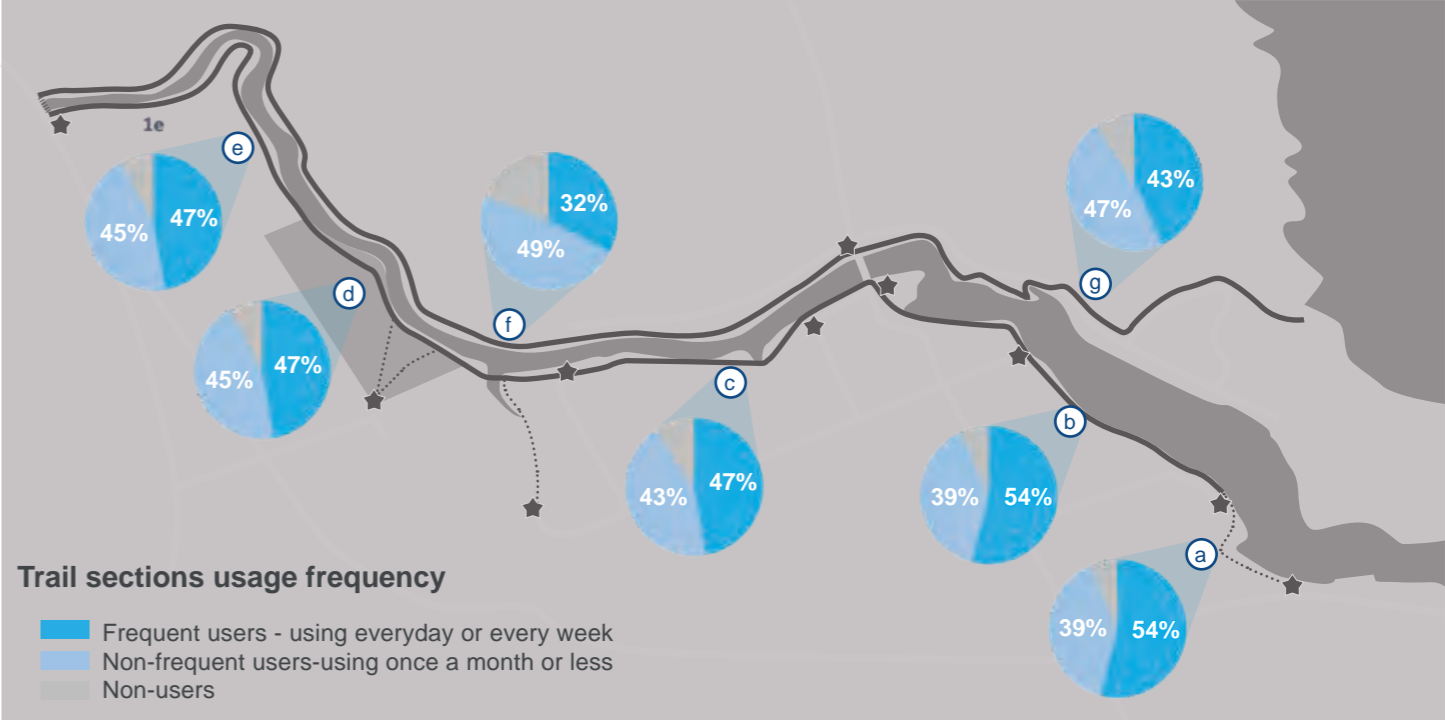

INGLIS RIVER WALKING TRAIL - Options Study

Waratah-Wynyard Council is undertaking an Options Study to improve the Inglis River Walking Trail. We are seeking your feedback to plan for the future and ensure that the trail meets the community’s needs. Please see the plan below for a map of the Trail.

WHY IS COUNCIL UNDERTAKING AN OPTIONS STUDY?
The Inglis River Walking Trail includes various structures such as boardwalks and bridges which are reaching the end of their lifespan and require replacement. Before starting the trail upgrades Council is doing research and testing options to ensure that any upgrades respond to environmental factors and the needs of the community.

WHAT IS INVOLVED?
The first phase of the project is discussions with key user groups and the broader community. The outcomes of this phase will help to identify issues and opportunities to be considered in the preparation of design options. The options will be assessed against a range of criteria to determine which should be taken up for detailed design and construction.

HAVE YOUR SAY!
Your feedback is important and will be used to ensure that the Master Plan meets the community’s needs.

IN PERSON
We will be holding community engagement drop-in sessions at Gutteridge Gardens picnic shelter on:
 • Friday 2 December, 12.30pm to 2.30pm
 • Saturday 3 December 9.30am to 11.30am

ONLINE
To fill in the online survey use the QR code below or go to www.warwyn.tas.gov.au/have-your-say. Comments close at 5:00pm Friday 9 December 2022.

Trail access points:

- (a) Wynyard Wharf to Jenner Street Boat Ramp (note: this section of trail is not included in the Study Area)
- (b) Jenner Street Boat Ramp to Cape Bridge
- (c) Cape Bridge to Big Creek Bridge
- (d) Big Creek Bridge to York Street Reserve
- (e) York Street Reserve to Bass Highway Bridge
- (f) Bass Highway Bridge to Cape Bridge
- (g) Cape Bridge to Fossil Bluff

Scale: 0m 250m 500m

WARATAH WYNYARD

Image: Flyer advertising public consultation

What are the most popular uses?

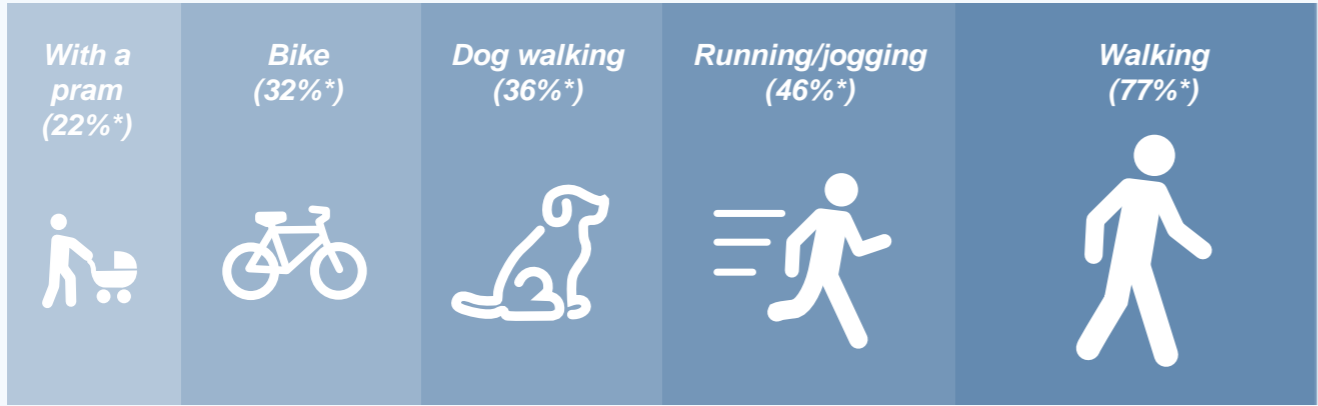

* To reflect the fact that individuals may use the the trail in more than one way, the survey allowed respondents to nominate more than one use. This means that percentages add up to more than 100%.

What factors make people less likely to use the trail?



Why do people use the trail?

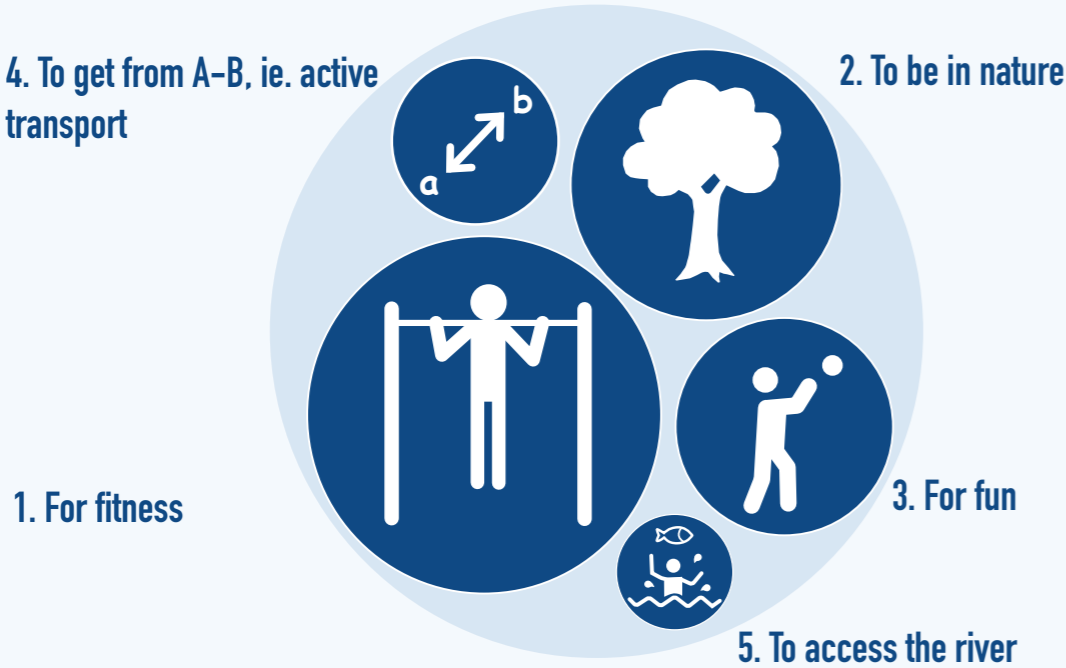

How can the trail be improved?

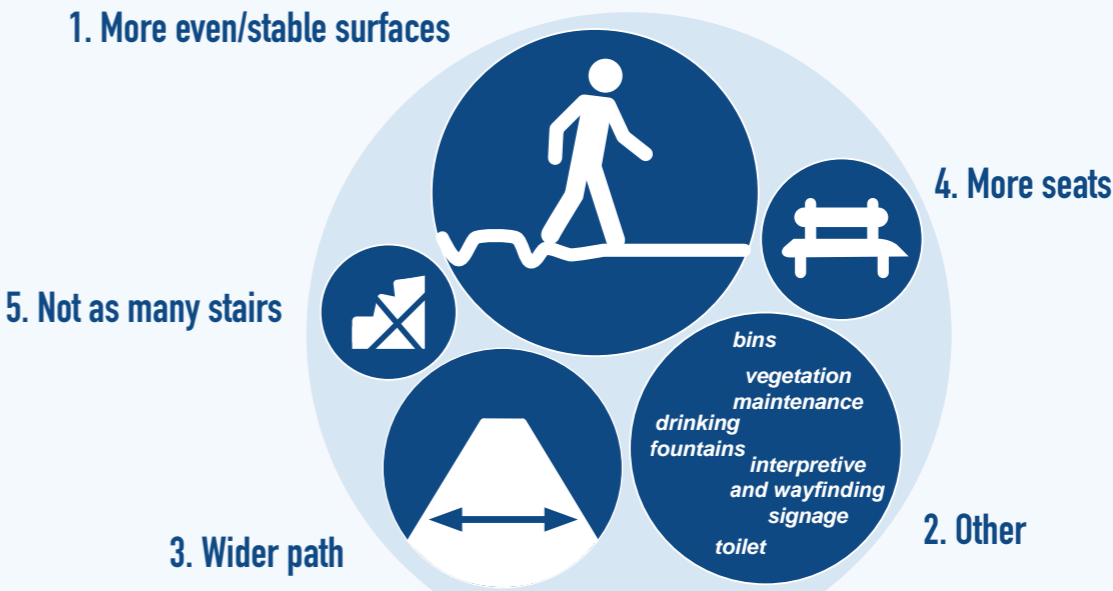

2 Site analysis

Site observations

Character and context

Inglis River Walking Track can be broadly divided into seven segments, each with a distinct character. The character of each segment is influenced by a range of factors, including track width and surface, gradient (of the track itself and the of the riverbank), vegetation type and surrounding context.

a) Wynyard Wharf to Jenner Street Boat Ramp. A sealed path bordered by manicured lawns (note: this section of trail is not included in the Study Area)



b) Jenner Street Boat Ramp to Cape Bridge. The track passes through urban bushland behind houses on the southern bank of the Inglis River.



c) Cape Bridge to Big Creek Bridge. The track winds through bushland behind the cemetery and primary school on the southern bank of the Inglis River.



d) Big Creek Bridge through York Street Reserve. The track winds through bushland at the edge of York Street Reserve on the southern bank of the Inglis River.



e) York Street Reserve to Bass Highway Bridge. Segments of boardwalk border low-lying farmland on the southern bank of the river.



f) Bass Highway Bridge to Cape Bridge. The track follows the northern bank of the river, including several short steep inclines, steps and boardwalks, before meeting River Road.



g) Cape Bridge to Fossil Bluff. The track runs along the northern bank of the river next to Golf Links Road, then through a residential area and up a grassy slope to the Bluff.



Vegetation character

The character of native vegetation along the track can be broadly classified into three main categories. Eucalypt woodland is the most commonly encountered category, however tree ferns are plentiful in shady areas fed by fresh water and patches of paperbark dominate low-lying sections of the river bank. There is an opportunity for future works and signage to enhance the character and ‘destination’ status of fern and paperbark-dominated vegetation types.

Many native plant species already present along the Track are visually appealing and provide seasonal interest. There is an opportunity for future planting works to enhance the experience of the trail for users by explicitly including species in revegetation that are nice to look at, particularly adjacent to the path.



Images: Site photos illustrating the distinct character of native vegetation along the Track

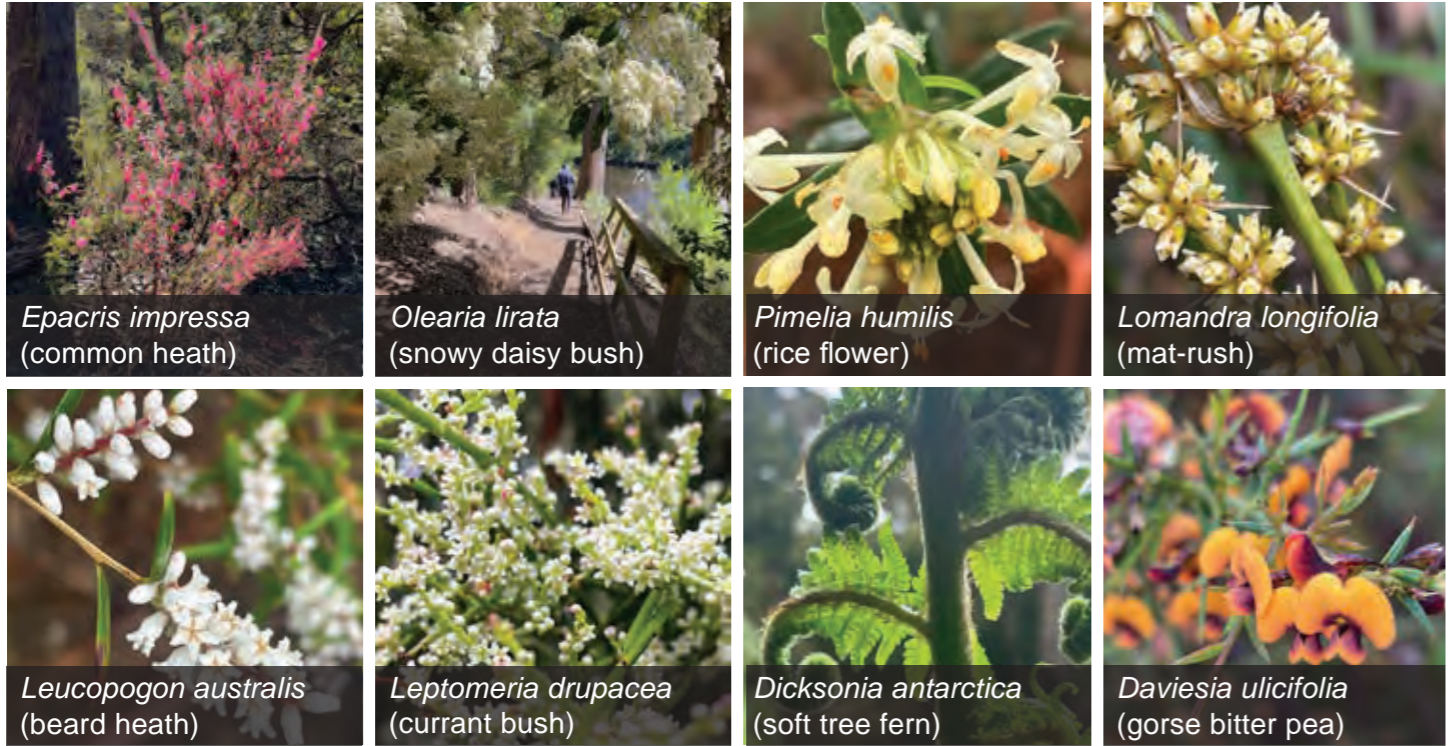

Images: Site photos showcasing visual appeal of species present on site

Unstable banks

A number of bank areas along the Track show signs of instability. There are also examples of revegetation which appears to have been successful in stabilising the bank. It is recommended that revegetation works are implemented in unstable bank areas. (Note that views to the river are highly valued by Track users - aim to provide areas of low planting to provide views through vegetation).



Images: Site photos showing unstable banks along the Inglis River Image: Example of revegetation along bank (near Bass Hwy, south bank)

Trees clashing with path

Mature trees clash with the path in many locations. In some cases roots are exposed. This is a problem for several reasons. In addition to reducing the width of the path and posing risk of trip/head bump hazards, damage to roots may be detrimental to the health of the tree, potentially leading to limb drop or even tree failure. It is recommended to realign the path away from the tree where possible to prevent damage to tree roots.



Images: Site photos showing mature trees clashing with path

Weeds

Patches of weeds are present in various locations along the Track, including English ivy, wandering creeper, blackberry and gorse. Preparation of a comprehensive management plan is recommended. There is potential for the community to become involved in weed management, particularly in areas close to residential areas.



Image: Yellow-tailed black cockatoo in York Street Reserve
by Bill Walker

Environmental values

Except where otherwise noted, the following information is based on the Natural Values Atlas, accessed 06.02.2023.

Overview

The Study Area is located within an area rich in flora, fauna and ecological value. It is home to numerous threatened species as well as non-threatened species of conservation significance, and the estuary itself is of high conservation significance.

Parts of the Study Area are affected by overlays relating to bushfire, priority vegetation and future coastal refugia - for further details refer to the Statutory Context section of this document.

Native vegetation communities (TASVEG)

Based on data provided by the LIST, the predominant native vegetation community across the Study Area is *Eucalyptus obliqua* wet forest (undifferentiated) (WOU). However, NRE notes that areas with this classification should be further investigated and re-coded to one of the following: *Eucalyptus obliqua* forest over rainforest (WOR); *Eucalyptus obliqua* forest over broad-leaf shrubs (WOB); or *Eucalyptus obliqua* forest over *Leptospermum* (WOL). Further complicating the matter, a 2020 Natural Values Assessment of York Street Reserve (which adjoins the Inglis River corridor and according to the LIST shares its 'WOU' classification) identified four vegetation communities within the reserve, none of which are included in the above list and one of which is listed as 'threatened' (refer to separate section below for further details). Therefore, it is reasonable to suspect that detailed surveys of the vegetation in the Inglis River corridor may produce a result different to what is recorded on the LIST.

The LIST shows patches of Saline sedgeland / rushland along the edges of the Inglis River east of Big Creek, *Pteridium esculentum* fernland just outside the Study Area on the north bank of Crowes Bend, and patches of *Melaleuca ericifolia* swamp forest and Riparian scrub (both threatened communities) along Big Creek, Camp Creek and in the Inglis River west of Bass Highway.

York Street Reserve Natural Values Assessment





As noted above a detailed Natural Values Assessment of York Street Reserve was undertaken in 2020 for Waratah-Wynyard Council by North Barker Ecosystem Services. The Assessment recorded four native vegetation communities:

- *Eucalyptus nitida* dry forest and woodland (DNI)
- *Eucalyptus obliqua* dry forest and woodland (DOB)
- *Eucalyptus ovata* forest and woodland (DOV)
- *Leptospermum lanigerum*-*Melaleuca squarrosa* swamp forest (NLM).

The DOV is listed as threatened under the NCA and under the EPBCA as Tasmanian Forests and Woodlands dominated by black gum or Brookers gum (*Eucalyptus ovata* / *E. brookeriana*).

The Assessment made management recommendations for protecting the natural values of the Reserve which included discouraging informal tracks, more interpretive signage, weed control, an awareness campaign about 'escapee' garden plants, pet management guidelines, and ongoing engagement of community groups who may wish to assist with management.

Native vegetation communities (TASVEG 4)

-  *Eucalyptus obliqua* wet forest
-  Saline sedgeland / rushland
-  *Pteridium esculentum* fernland (note: outside Study Area)
-  *Melaleuca ericifolia* swamp forest (note: outside Study Area)



-  **Threatened flora (per the LIST)**
-  **Threatened flora (per Council officers)**



Image: Plan showing high-level vegetation information

Freshwater ecosystems

The estuarine area of the Inglis River adjacent to the Study Area has been assessed by the Conservation of Freshwater Ecosystem Values Program (CFEV), a statewide audit and conservation evaluation of Tasmania's freshwater dependent ecosystems. It is rated as having High Integrated Conservation Value and as being of Very High Conservation Management Priority.

Threatened flora

The Study Area contains specimens of several native flora species which are classified as 'threatened'. Other threatened species have been found within 500m of the Study Area. The Study Area and/or its surrounds within 500m are also home to over sixty non-threatened species of conservation significance.

Threatened flora within 500m of the Study Area:

- *Chiloglottis trapeziformis* (broadlip bird-orchid)
- *Chiloglottis valida* (large bird-orchid)
- *Gynatrix pulchella* (fragrant hempbush)

Weed species

Several weed species are prevalent within the Study Area, including some listed in the Tasmanian Management Act and others listed as 'priority weeds'.

Tasmanian Management Act weeds within 500 metres of the Study Area (verified records)

- *Erica lusitanica* (spanish heath)
- *Genista monspessulana* (montpellier broom or canary broom)
- *Rubus fruticosus* (blackberry)
- *Ulex europaeus* (gorse)

Priority weeds within 500 metres of the Study Area (verified records)

- *Acacia baileyana* (cootamundra wattle)
- *Grevillea rosmarinifolia* (rosemary grevillea)
- *Pittosporum undulatum* (sweet pittosporum)
- *Tradescantia fluminensis* (wandering creeper)

Environmental weeds identified for management in the 2020 Natural Values Assessment of York Street Reserve by North Barker Ecosystem Services were:

- *Pinus radiata* (radiata pine)
- *Vinca major* (blue periwinkle)
- *Digitalis purpurea* (foxglove)
- *Passiflora tarminiana* (banana passionfruit)

Threatened fauna

There have been numerous verified sightings within the Study Area of native fauna species classified as 'threatened'. Further sightings have been recorded within 500m of the Study Area, and additional species may be expected to be present in the area based on range boundaries. The Study Area and/or its surrounds within 500m are also home to approximately three hundred non-threatened species of conservation significance.

The 2020 Natural Values Assessment of York Street Reserve noted that 'the reserve is expected to be of limited utility to most threatened species of fauna primarily due to its size and isolation, but it will serve as an important 'island' or 'refuge' of native habitat for species traversing the area (e.g. Tasmanian devil). The reserve is also important for azure kingfisher in the area, and indeed any species reliant on the Inglis River,

as it serves as a buffer of native vegetation to the Inglis River Reserve' (North Barker Ecosystem Services, p. 2).

Threatened fauna within 500 metres of the Study Area (verified records)

- *Accipiter novaehollandiae* (grey goshawk)
- *Alcedo azurea* subsp. *diemenensis* (azure kingfisher or azure kingfisher (Tasmanian))
- *Aquila audax* (wedge-tailed eagle)
- *Aquila audax* subsp. *fleayi* (Tasmanian wedge-tailed eagle)
- *Arctocephalus forsteri* (New Zealand fur seal)
- *Arctocephalus tropicalis* (sub-antarctic fur seal)
- *Beddomeia capensis* (hydrobiid snail (Table Cape))
- *Ceyx azureus* subsp. *diemenensis* (Tasmanian azure kingfisher)
- *Dasyurus maculatus* (spotted-tail quoll)
- *Eubalaena australis* (southern right whale)
- *Haliaeetus leucogaster* (white-bellied sea-eagle)
- *Hirundapus caudacutus* (white-throated needle-tail)
- *Lathamus discolor* (swift parrot)
- *Mirounga leonina* (southern elephant seal)
- *Numenius madagascariensis* (eastern curlew)
- *Prototroctes maraena* (Australian grayling)
- *Sarcophilus harrisii* (Tasmanian devil)
- *Thinornis rubricollis* (hooded plover)
- *Tyto novaehollandiae* (masked owl)

Threatened fauna within 500 metres of the Study Area (based on Range Boundaries)

- *Engaeus yabbimunna* (Burnie burrowing crayfish)
- *Dasyurus maculatus* subsp. *maculatus* (spotted-tail quoll)
- *Astacopsis gouldi lutaralipina* (giant freshwater crayfish)
- *Litoria raniformis* (green and gold frog)
- *Lathamus discolor* (swift parrot)
- *Prototroctes maraena* (Australian grayling)
- *Beddomeia capensis* (hydrobiid snail (table cape))
- *Ceyx azureus* subsp. *diemenensis* (Tasmanian azure kingfisher)
- *Pseudemoia pagenstecheri* (tussock skink)
- *Haliaeetus leucogaster* (white-bellied sea-eagle)
- *Oreisplanus munionga* subsp. *larana marrawah* (skipper)
- *Limnodynastes peroni* (striped marsh frog)
- *Tyto novaehollandiae* subsp. *castanops* (masked owl (Tasmanian))
- *Galaxiella pusilla* (eastern dwarf galaxias)
- *Accipiter novaehollandiae* (grey goshawk)
- *Sarcophilus harrisii* (Tasmanian devil)
- *Perameles gunnii* (eastern barred bandicoot)
- *Aquila audax* subsp. *fleayi* (Tasmanian wedge-tailed eagle)

Conclusions

Based on the information reviewed the Study Area includes important existing environmental values, and the Track interacts with (or has the potential to interact with) many of them. Opportunities exist to enhance these values, especially when moving the path to less vulnerable areas, thereby creating revegetation opportunities in the former alignment. It is recommended that removal of infrastructure associated with the old path, and revegetation of the area, are factored into undertaking works.

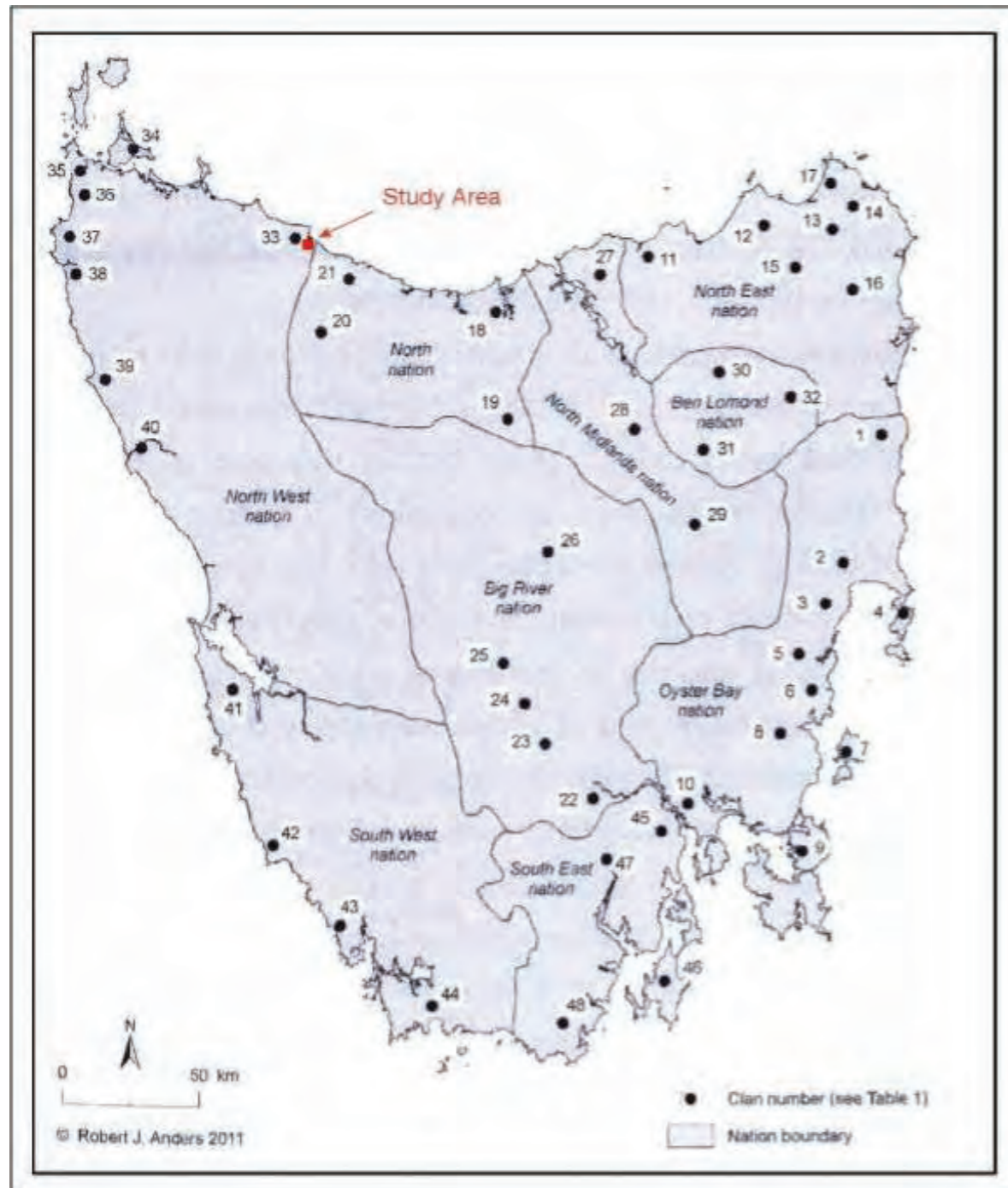

Location of the Study Area
Image: reproduced by CHMA

Cultural heritage values

The following is based on information contained in the Aboriginal Heritage Assessment prepared by specialist heritage consultants Cultural Heritage Management Australia. For full details refer to the document included in the Appendix to this Study.

The Study Area is situated on or near the boundary of the North West Nation and the Northern Nation. The territory of the North West Nation extended from Table Cape in the east through to Cape Grim and south down to the northern end of Macquarie Harbour. The North West Nation was believed to comprise between 400-600 individuals, who were divided into eight separate clans. The Tommegine are the clan that is identified as occupying the area around Table Cape. The North-West people moved up and down the coast, travelling along well-established routes in order to gain access through the densely forested coastal fringes, and the low-lying swamp areas that were also covered with thick tea tree scrub. In late winter and September, people congregated at the mouths of rivers near coastal lagoons to collect swan and duck eggs. The sheltered estuarine flats of the north coast were particularly appealing for this activity.

The territory of the Northern Nation extended from Port Sorrell to the west of Emu Bay, and then inland through to the southwest corner of Surrey Hills, and west to the base of the Western Tiers. The people of the Northern Nation moved through their territory via a series of well-defined walking tracks or routes, which were kept open through regular firing. The cold winter months of the year were mainly spent on the coastline. In early spring, between August and September, the people of the North Tribe are believed to have congregated around Port Sorrell and the mouths of other major north coast rivers to collect the eggs of swans, ducks and other water birds.

Aboriginal Heritage Assessment

As part of the Study an Aboriginal Heritage Assessment was prepared by specialist heritage consultants Cultural Heritage Management Australia along with a Senior Aboriginal Heritage Officer. The early phase of the Assessment included a search of the Aboriginal Heritage Register (AHR) which determined that there are a total of 24 registered Aboriginal heritage sites that are situated within a 5km radius of the study area (search results provided by Joel Williams from AHT on 16-11-2022). Fourteen of these sites are classified as isolated artefacts, six are classified as artefact scatters, two are classified as shell middens, one is classified as a stone arrangement and lastly, one is classified as 'not a site/stone quarry'.

Several registered artefact sites are located within the Study Area and a field survey undertaken as part of this Study uncovered two additional artefacts. The survey did not find evidence of stone artefact manufacturing or Aboriginal rock shelters, however, given that surface visibility across the study area was variable, it cannot be stated with certainty that there are no undetected Aboriginal heritage sites present in the proposed Inglis River Walking Track Options Study footprint.



Image: Erosion at the mouth of Big Creek.



Image: Erosion on upper side of path, south bank between Bass Hwy and York St Reserve



Image: High side of the Track showing erosion, south bank between Bass Hwy and Crowes Bend



Image: Macroporpha roots holding soil along the boundary of the river corridor, north bank



Image: Red soil eroding on the north bank near Cape Bridge



Image: The Track within the landslip area on the north bank of Crowes Bend.

Erosion and landslip

Parts of the Study Area affected by Low and Medium Landslip hazard bands are the north bank of Crowes Bend (at the west end of the Study Area), the riverbank along Golf Links Road, and Fossil Bluff.

A substantial part of the coastline is affected by Coastal Erosion hazard bands. These extend into the mouth of the river almost to Cape Bridge, and include areas of High and Medium hazard directly adjacent to or under the Track. Site observations, media reports and anecdotal evidence suggest that land stability issues continue along the banks of the Inglis River to Bass Highway and beyond.

Overlays relating to erosion and landslip also affect the Study Area. Refer to the Statutory Context section of this document for details.



Non-coastal erosion: site observations



Coastal Erosion Hazard Bands 20161201

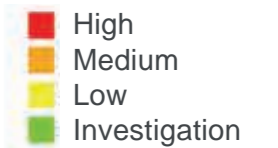

Landslide Planning Map Hazard Bands 20131022

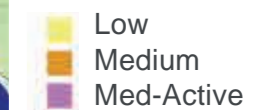



Image: The seating area at Big Creek is submerged at king tide, with water reaching the bottom step of the bridge.



Image: Deep cracks in the regularly inundated area near Crowes Bend



Image: Small bridges cross the permanent water at this point between Crowes Bend and Cape Bridge, but the path shows evidence of inundation.



Image: Much of the Cape Bridge Picnic Area is given over to roadway and car park, pushing recreational activities to the low-lying edges.



Image: Path washout, south bank near Bass Hwy.



Image: Two small bridges provide path links over permanent water in a low-lying area off Golf-Links Road.

Sea level rise and storm tide

Low-lying areas along the river corridor are currently subject to inundation. State government mapping relating to projected 1% Annual Exceedance Probability (AEP) storm tide and sea level rise over the coming decades shows these areas increasing in extent. Nevertheless a substantial area of the river corridor is projected to remain outside the zone directly affected, suggesting that the continued presence of a walking track along the river is a feasible proposition.

Parts of the Study Area are also affected by overlays relating to flooding and inundation. Refer to the Statutory Context section of this document for details.



Coastal Projected Storm Tide 20161201



Coastal Projected Sea Level Rise 20161201

1%AEP 2010
1%AEP 2050
1%AEP 2100

Predicted Rise 2100
Predicted Rise 2150

Statutory context

Zones

The majority of the Study Area is zoned Environmental Management, with the exception of the southern bank east of Cape Bridge, which is zoned Open Space. Bordering land is primarily residential land zoned Rural or General Residential, with areas of Agriculture and Low Density Residential land near the Cape Bridge on Golf Links Road. Schools and a cemetery are located in the area zoned Community Purpose on the central southern bank, while the cricket ground and golf course at the east end of the Study Area are both zoned for Recreation. The area zoned General Business is located at the south-east end of the Study Area, while the west end of the Study Area borders an area zoned General Industrial.

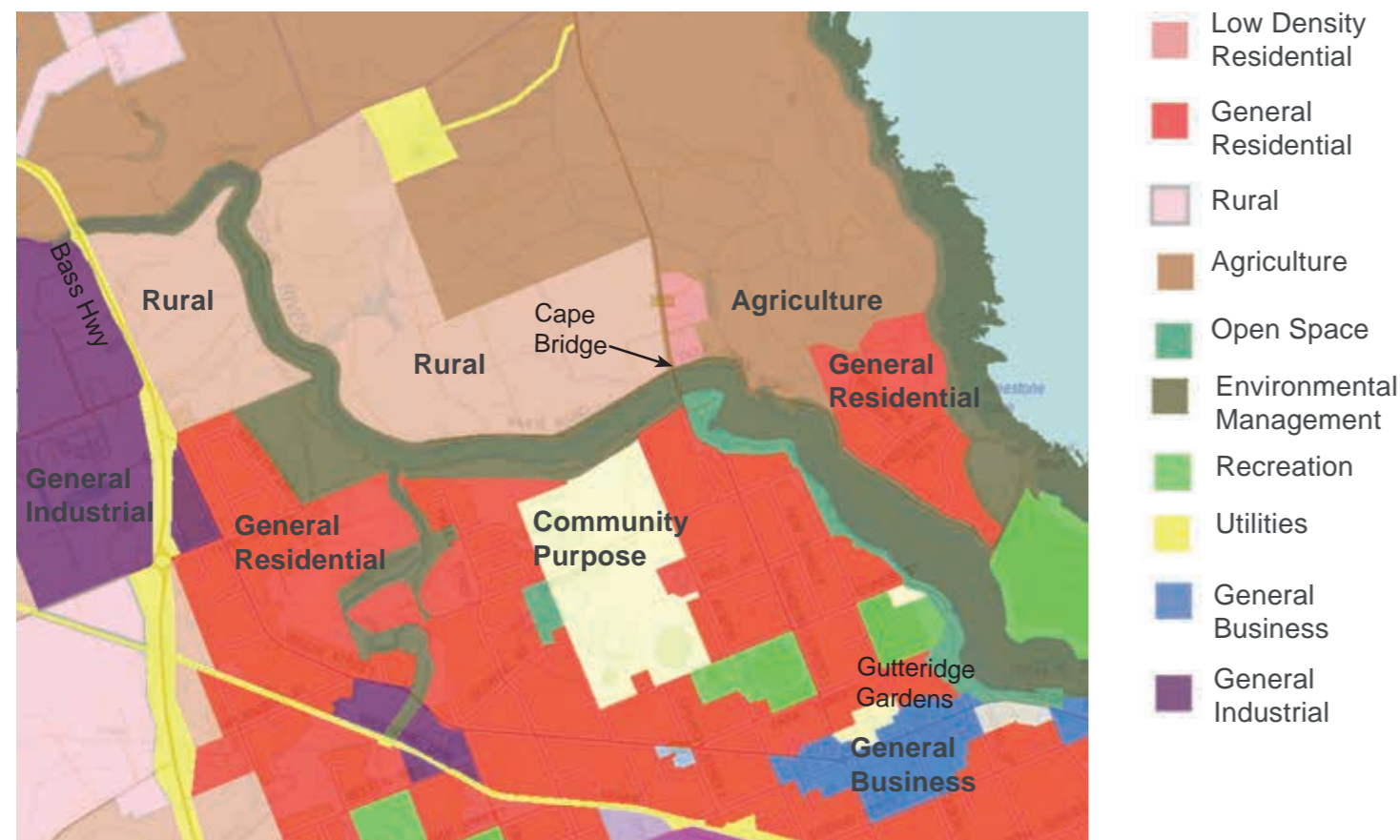

Tasmanian Planning Scheme - Zones

Overlays

The Study Area is subject to a number of overlays, including Flood prone area, Coastal Inundation Hazard, Priority Vegetation, Future Coastal Refugia, Coastal erosion, Coastal erosion investigation and Landslip hazard. The extents of these overlays have been included in this report to emphasise the statutory importance of addressing related issues in the Options Study.

The Study Area is also affected by the Bushfire-prone area overlay (which affects the west and north of the Study Area) and the Airport obstacle limitation overlay (this overlay covers Wynyard as a whole and as such an image has not been included).



Tasmanian Planning Scheme - Coastal Erosion Area Overlay



Tasmanian Planning Scheme - Coastal Erosion Area - Investigation Area Overlay



Tasmanian Planning Scheme - Priority Vegetation Overlay



Tasmanian Planning Scheme - Flood Prone Areas Overlay



Tasmanian Planning Scheme - Future Coastal Refugia Overlay



Tasmanian Planning Scheme - Coastal Inundation Hazard Overlay



Tasmanian Planning Scheme - Bushfire-prone Area Overlay



Tasmanian Planning Scheme - Landslip Hazard Overlay

Title boundaries

Aerial imagery overlaid with cadastral plans appears to indicate that in some cases private fences or landscaping have been constructed outside property title boundaries, within the river corridor. This may cause difficulties should path realignment be required to bring the track away from sensitive vegetation and flood and/or erosion prone areas, or to create a more accessible path by reducing the gradient and/or increasing the width of the track.

Note that at this stage no clashes have been officially confirmed by a surveyor. It is recommended that a boundary survey is undertaken by a qualified professional surveyor along the full length of the river corridor to provide clarity for all stakeholders.



Image: Cadastral boundaries over aerial image

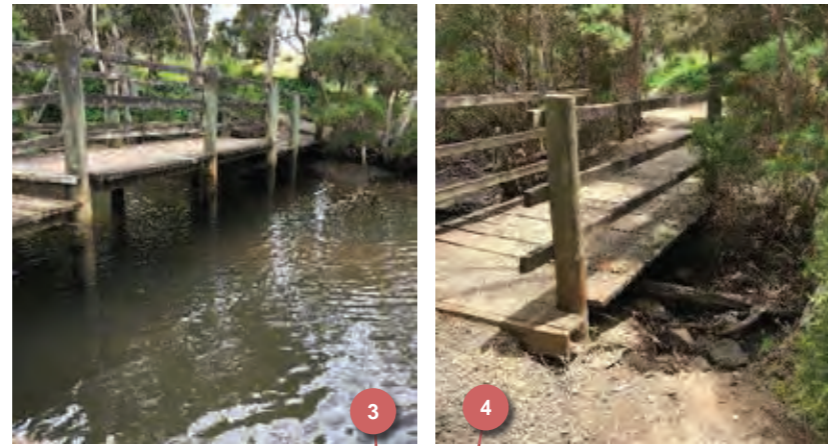

Track and structures condition

Summary

As part of the Study a Condition Assessment Report was prepared by structural engineers Rare Innovation. The Report outlines the existing condition of structure and infrastructure along the Inglis River walking track and its susceptibility to erosion, flood, and other deterioration. It also provides a preliminary strategy for footway and structure replacement and improvement.

Rare used engineering judgement in conjunction with information provided by Council as a reference point from which to base their evaluations. The Report uses both existing classifications for discrete elements as well as further segmenting sections of the walkway to provide a useful summary of remediation work and the priority with which to address any issues. The conclusion of work identifies several areas of trail that require remediation work to serve the design intent as a positive asset for the local community and wider stakeholder group.

A classification of the issues identified was provided with an accompanying generalised method for repair. A priority level was also assigned to guide the overall approach to allocating works and timeline for ongoing Inglis River walking track remediation.

Key points

125 'elements of consequence' were recorded along Inglis River that deviated from clear and serviceable walkway condition.

- The majority of elements were identified as being in 'satisfactory condition'.
- 4 structural elements were identified as being 'at end of design life' (ie. requiring replacement or recertification).
- 16 structural elements were identified as requiring 'general maintenance'.

The structural elements identified as being 'at end of design life' (requiring replacement in the next year to two years) were (refer to adjacent plan):

- (1) **WWC list no. 139.** Ramp from road level leading into a flight of timber stairs toward the river. Stairs terminate on the river-side close to riverbank height. Recommend replacement/renewal within 1 year from time of assessment.
- (2) **WWC list no. 141.** Multi-span timber bridge over significant river inlet with multiple braced piers. Soil obscuring view of abutments at Western end. Recommend replacement/renewal within 2 years from time of assessment.
- (3) **WWC list no. 150.** Significant timber bridge structure crossing approximately 25m water. Central 10m is raised by a stair level. Recommend immediate replacement/renewal.
- (4) **WWC list no. 151.** Approximately 10m timber bridge structure of smaller river inlet, at the time of inspection a low amount of water below the deck. Recommend immediate replacement/renewal.

The full Condition Report can be found in the Appendix to this document.

4 Issues and opportunities

This section brings together information gathered during the Study to provide a basis for decision-making. An Issues and Opportunities Plan on the following page provides a visual summary of key factors affecting the Study Area. This information has formed the basis for development and prioritisation of the track improvement options which are explored in the following section of this document and may be useful in planning for future improvement projects.

This section also considers opportunities for reducing the maintenance burden on Council and improving management outcomes.

Community involvement in management

A significant opportunity exists for community groups to be involved in management of the Track. This has the potential to improve site outcomes and increase a sense of community ownership as well as assisting Council.

Specifically, the local Landcare group includes members with useful experience and expertise in environmental management and has a track record of working productively with Council to inform and improve management processes in such areas as slashing/poisoning protocol, site environmental pre-project survey and roadside verge mapping. A successful example of this is the Sisters Beach Management Plan (a draft version of which is included in the Appendix to this document). The Plan is based on a thorough survey of vegetation and other site issues. It outlines practical processes to achieve a number of identified aims, whilst meeting the requirements and procedures of Council Road Management operations.

Public consultation revealed interest within the community which could be channeled into a Friends group or similar. Such a group may be able to help control weeds, collect litter, fundraise and undertake planting. Schools which border the Study Area may be interested in incorporating management activities into the curriculum. (It is noted that establishment of a management plan would be pre-requisite to provide guidance for these initiatives.)

Materials

The majority of structures along the Track are made of timber. While timber is readily available, easy to repair and reasonably cheap to buy, there are other materials which provide benefits in terms of maintenance requirement and overall life span. These benefits may outweigh a greater cost at time of construction and the change of aesthetic to one which may be less appealing to some. Alternative decking materials such as fibre reinforced plastic (FRP) grating - already used on two bridges within the Study Area - can also provide better grip than timber, making it particularly appealing in damp areas.



Image at left: Existing metal frame bridge with grating deck, located west of Crows Bend

Issues and opportunities plan



Track and structures condition
 ⚡ Structures at end of design life

Frequency of track use (per survey results)
 Most used
 (Red line)
 (Orange line)
 (Yellow line)
 (Light orange line)
 Least used

..... Potential trail links

Destination points and infrastructure
 p Picnic
 v Views
 t Toilets
 A Registered Artefact site
 F Threatened flora registered location

- 1 Potential to link with trail along Camp Creek.
- 2 Opportunity to realign the Track out of residential streets up the south side of Fossil Bluff.
- 3 Opportunity to improve accessibility of destination points by adding public toilets and improving existing picnic facilities and pedestrian infrastructure.
- 4 Potential to realign Track away from unstable edges.
- 5 Potential to realign Track up the bank to avoid inundation/requirement for boardwalk and reduce impact on sensitive environments.
- 6 Potential to improve pedestrian safety at crossing points on north and south sides of Cape Bridge, for example by introducing traffic calming measures and reducing crossing distance.
- 7 Potential to reduce erosion and provide for use of area during periods of inundation by installing boardwalk (including seating) at base of bridge.
- 8 Limited potential for retreat from unstable ground or inundation due to narrow corridor and/or steep gradient.

5 Track improvement projects

Summary of approach

Locations for potential improvement projects were determined by cross-referencing the items nominated as most urgent by the Condition Report (ie. structures nearing the end of their life span and requiring replacement in the near future) with the items identified as most important by the community during consultation (ie. improvements that people most want to see, in places that people most want to use).

The locations identified for further study were:

- 1 Boat Ramp to Picnic Ground
- 2 Esplanade to Cemetery
- 3 Big Creek Bridge
- 4 North York Street Reserve to Bass Highway
- 5 Golf Links Road

Potential improvement projects in each location are shown in further detail over the following pages. Recommendations include:

- Measures to eliminate stairs and steep gradients from heavily used segments of track.
- Minimum width targets.
- Realignment of the track away from areas susceptible to erosion and inundation ('risk zones').
- Revegetation works along former track alignment.

An indicative costing (including allowances for additional items such as seating and signage) is provided for each project in the 'Implementation' section of this document.



Image: Locations of improvement projects

Track improvement project 1 - Boat Ramp to Picnic Ground (sheet 1 of 2)

SECTION:
(b) Jenner Street Boat Ramp to Cape Bridge

TYPICAL PROPOSED PATH WIDTH: 2m

NOMINAL PWS PATH CLASSIFICATION:
W1 (Wheelchair standard nature trail).

NOTES:
- Refer to typical details at the end of this section.
- Construction within protection zones of existing trees to be undertaken using non-invasive techniques. A Tree Protection Plan (if required) to be prepared by a qualified Arborist.
- A Flora and Fauna Report (if required) is to be prepared by a qualified Ecologist.
- Title boundaries and location of any services to be determined prior to construction.
- This drawing is based on GIS data provided by Waratah-Wynyard Council, information obtained from the LIST and site observations, and is intended for general information and planning purposes only. A detailed site survey should be undertaken prior to commencing detailed design.

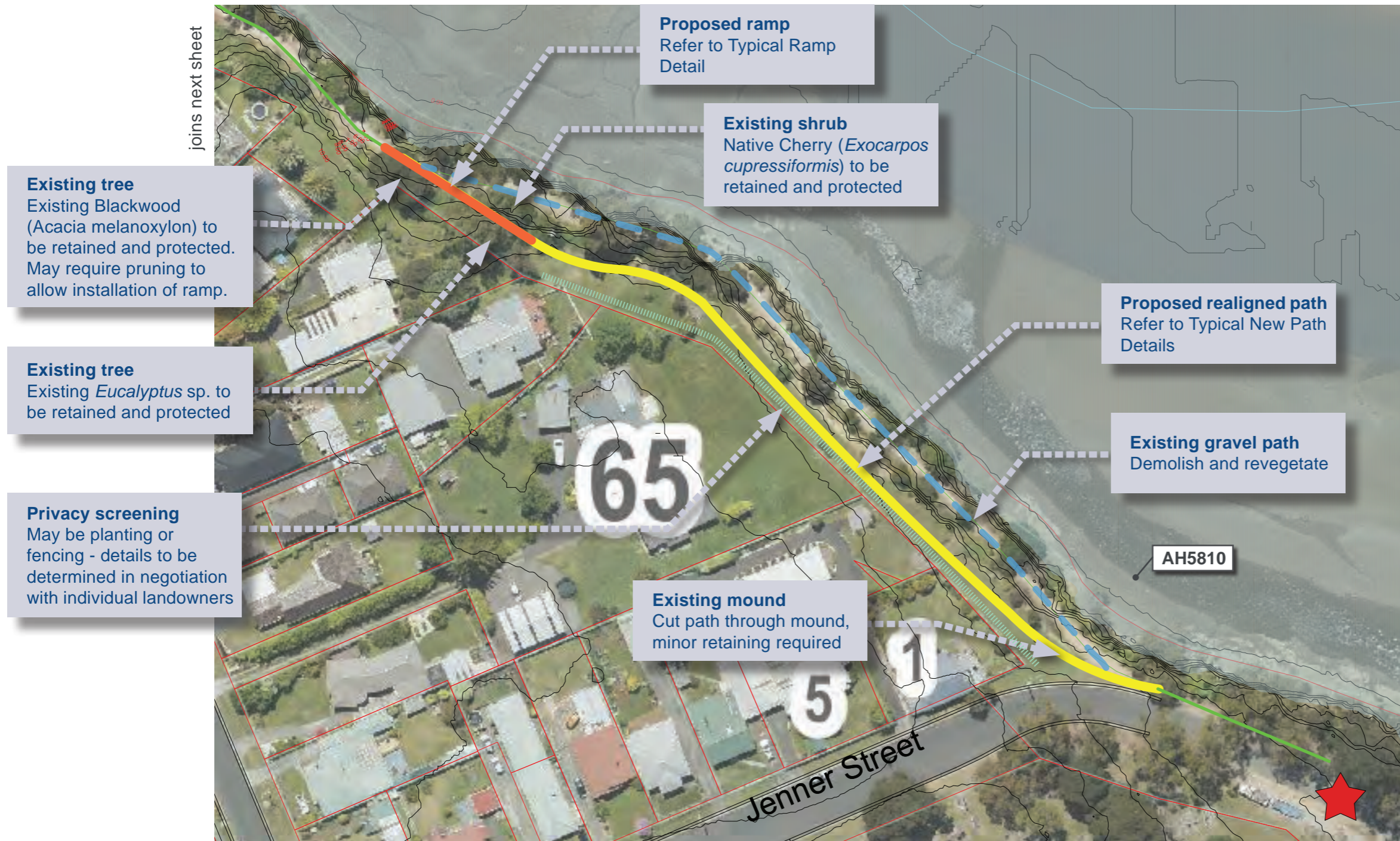

LEGEND

- Title Boundary
- Existing Inglis River Trail alignment
- - - Existing path/structure to be demolished and revegetated/made good
- Proposed trail alignment
- Proposed trail structure
- Risk zone (sea level rise)
- ★ Existing trail entrance
- Privacy screening
- AS1 Registered Aboriginal Artefact (note: approx. location shown)

Track improvement project 1 - Boat Ramp to Picnic Ground (sheet 2 of 2)

Proposed realignment
Realigned path away from risk zone and sensitive vegetation. Connect to existing path through trees. Refer to Typical New Path Details.

Sensitive vegetation
Existing patch of paperbarks to be retained and protected.

Existing steep culvert
Provide balustrade and make good to replace lost manhole and embankment zone

Existing trees
Existing patch of *Eucalyptus* sp. to be retained and protected

Existing lower path
Demolish and revegetate

Existing path connections
Retain

Proposed realignment
Realign path away from steep edge and reduce encroachment to existing native vegetation. Refer to Typical New Path Details.

Existing risk zone
Potential future realignment or structure required to manage risk

Existing boardwalk
Demolish and revegetate area

Proposed ramp
Refer to Typical Ramp Detail

LEGEND

- Title Boundary
- Existing Inglis River Trail alignment
- Existing trail structure
- Existing path/structure to be demolished and revegetated/made good
- Proposed trail alignment
- Proposed trail structure
- Risk zone (sea level rise)
- Risk zone (storm tide encroachment)
- Risk zone (coastal erosion hazard band)
- Existing trail entrance



joins previous sheet

Track improvement project 2 - Esplanade to Cemetery (sheet 1 of 1)

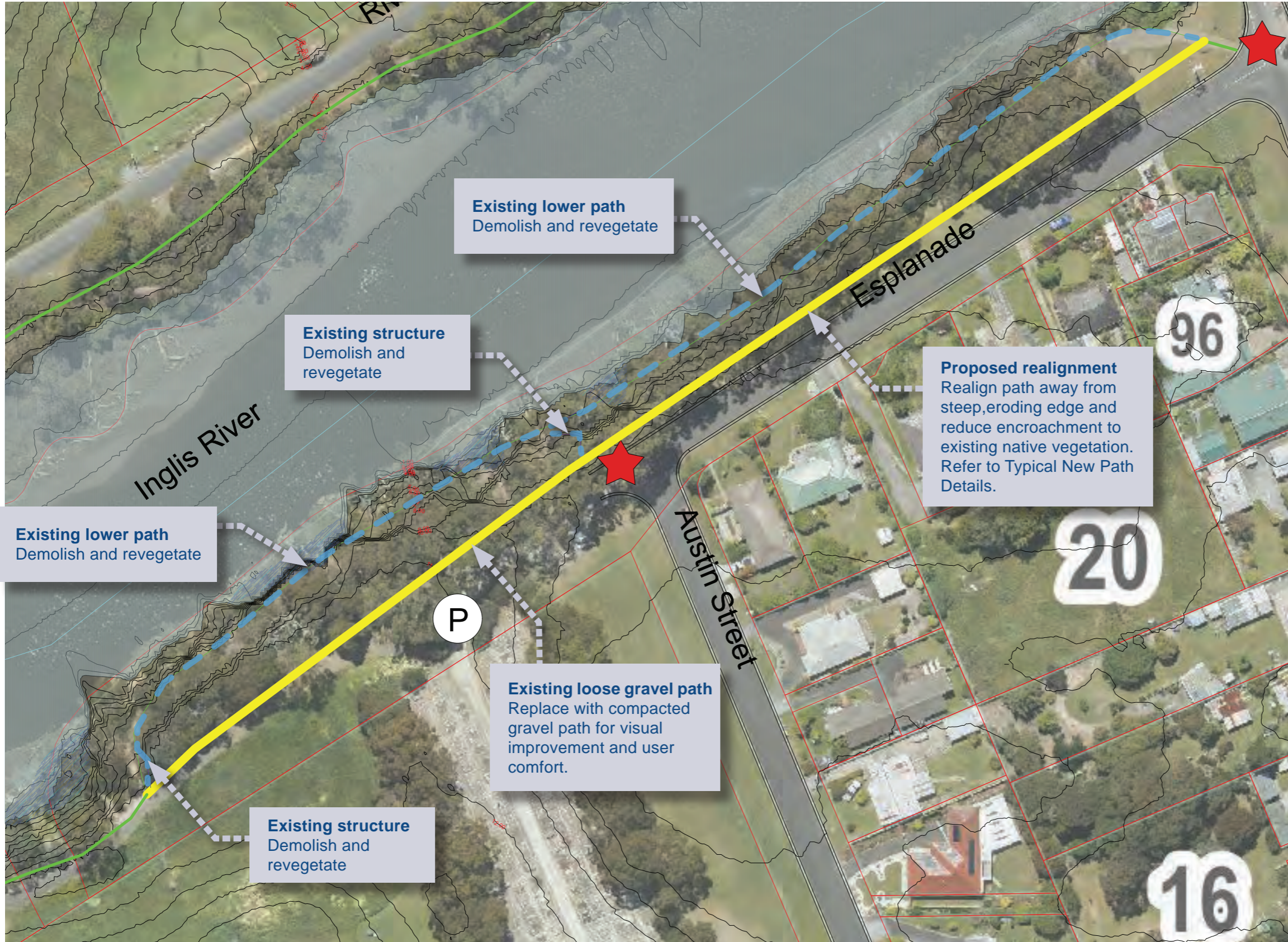

SECTION:
 (c) Cape Bridge to Big Creek Bridge

TYPICAL PROPOSED PATH WIDTH: 2m

NOMINAL PWS PATH CLASSIFICATION:
 W1 (Wheelchair standard nature trail).

NOTES:

- Refer to typical details at the end of this section.
- Construction within protection zones of existing trees to be undertaken using non-invasive techniques. A Tree Protection Plan (if required) to be prepared by a qualified Arborist.
- A Flora and Fauna Report (if required) is to be prepared by a qualified Ecologist.
- Title boundaries and location of any services to be determined prior to construction.
- This drawing is based on GIS data provided by Waratah-Wynyard Council, information obtained from the LIST and site observations, and is intended for general information and planning purposes only. A detailed site survey should be undertaken prior to commencing detailed design.

- LEGEND**
- Title Boundary
 - Existing Inglis River Trail alignment
 - Existing path/structure to be demolished and revegetated/made good
 - Proposed trail alignment
 - Risk zone (sea level rise)
 - ★ Existing trail entrance

Track improvement project 3 - Big Creek Bridge (sheet 1 of 1)

Replace bridge
 Replace existing structure with 2m wide bridge with more durable materials and supports relocated away from mid-stream. Refer to Big Creek Bridge Replacement Detail.

Eliminate former track
 Demolish (or block) and revegetate old track infrastructure.

Eliminate 'goat track'
 Block and revegetate 'goat track' around tree (suspected use by BMX riders).

Proposed deck area
 Proposed deck area off boardwalk with seating (to create destination point from Cape Bridge)

Existing path link
 Big Creek path link falls within risk zone and has already been closed off

Proposed boardwalk
 Provide boardwalk extension to bridge structure to raise path above flood level. Min. 2m width. Refer to Typical Boardwalk Detail.

Existing lower path
 Demolish and revegetate

Proposed realignment
 Realign path away from risk zone. Refer to Typical New Path Details.

Existing loose gravel path
 Replace with compacted gravel path for visual improvement and user comfort

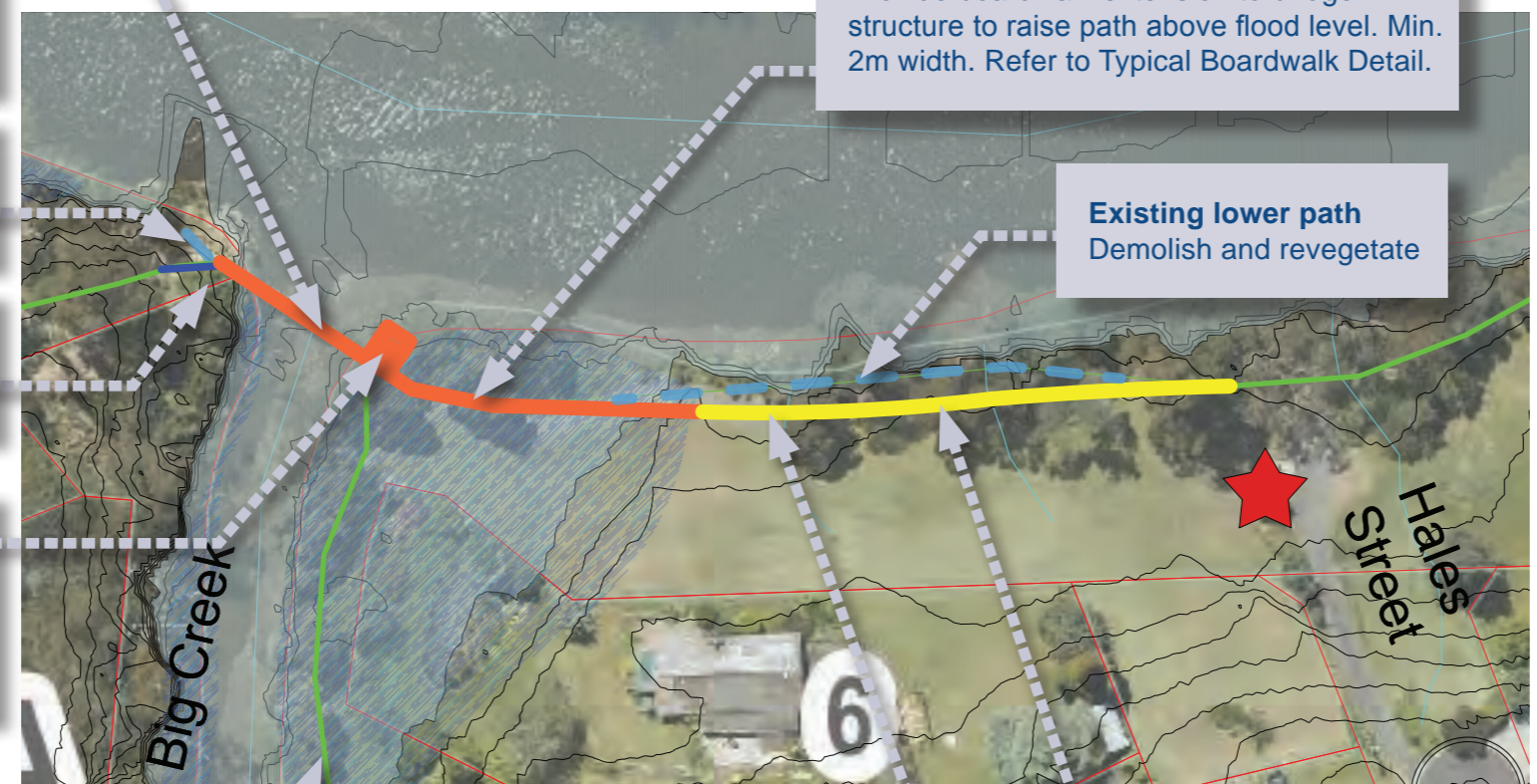

SECTION:
 (c) Cape Bridge to Big Creek Bridge

TYPICAL PROPOSED PATH WIDTH: 2m

NOMINAL PWS PATH CLASSIFICATION:
 W1 (Wheelchair standard nature trail).
 (Change to W2 (Standard nature trail) on west side of bridge)

NOTES:

- Refer to typical details at the end of this section.
- Construction within protection zones of existing trees to be undertaken using non-invasive techniques. A Tree Protection Plan (if required) to be prepared by a qualified Arborist.
- A Flora and Fauna Report (if required) is to be prepared by a qualified Ecologist.
- Title boundaries and location of any services to be determined prior to construction.
- This drawing is based on GIS data provided by Waratah-Wynyard Council, information obtained from the LIST and site observations, and is intended for general information and planning purposes only. A detailed site survey should be undertaken prior to commencing detailed design.

- LEGEND**
- Title Boundary
 - Existing Inglis River Trail alignment
 - Existing trail structure
 - - Existing path/structure to be demolished and revegetated/made good
 - Proposed trail alignment
 - Proposed trail structure
 - Risk zone (sea level rise)
 - Risk zone (storm tide encroachment)
 - Risk zone (coastal erosion hazard band)
 - ★ Existing trail entrance

Track improvement project 4 - North York Street Reserve to Bass Highway (sheet 1 of 3)



Proposed alignment
Align path to achieve required grade. Refer to Typical New Path Details.

Proposed boardwalk or bridge
Construct boardwalk or bridge structure over inlet. Note that maintenance vehicle access is expected to be from south and north of bridge, therefore bridge is to be engineered for pedestrian use only. Refer to Typical Boardwalk Detail.

Proposed alignment
Align path to achieve required grade

Privacy screening
May be planting or fencing - details to be determined in negotiation with individual landowners

Proposed alignment
Align path to achieve required grade

Existing path and boardwalk
Demolish and revegetate

Existing path and boardwalk
Demolish and revegetate

SECTION:
(e) York Street Reserve to Bass highway

TYPICAL PROPOSED PATH WIDTH: 2m path with min. 1m clear, stable shoulder/s to allow for maintenance vehicle access

NOMINAL PWS PATH CLASSIFICATION:
W2 (Standard nature trail)

NOTES:

- Refer to typical details at the end of this section.
- Construction within protection zones of existing trees to be undertaken using non-invasive techniques. A Tree Protection Plan (if required) to be prepared by a qualified Arborist.
- A Flora and Fauna Report (if required) is to be prepared by a qualified Ecologist.
- Title boundaries and location of any services to be determined prior to construction.
- This drawing is based on GIS data provided by Waratah-Wynyard Council, information obtained from the LIST and site observations, and is intended for general information and planning purposes only. A detailed site survey should be undertaken prior to commencing detailed design.

- LEGEND**
- Title Boundary
 - Existing Inglis River Trail alignment
 - Existing path/structure to be demolished and revegetated/made good
 - Proposed trail alignment
 - Proposed trail structure
 - Risk zone (sea level rise)
 - ★ Existing trail entrance
 - Privacy screening

Track improvement project 4 - North York Street Reserve to Bass Highway (sheet 2 of 3)



Existing path
Demolish and revegetate

Proposed alignment
Align path to achieve required grade. Refer to Typical New Path Details.



Proposed realignment
Align path away from risk zone and stabilise edge where required

Existing path and boardwalk
Demolish and revegetate

- LEGEND**
- Title Boundary
 - Existing Inglis River Trail alignment
 - - - Existing path/structure to be demolished and revegetated/made good
 - Proposed trail alignment
 - Risk zone (sea level rise)
 - ★ Existing trail entrance
 - AS1 Registered Aboriginal Artefact (note: indicative location and temporary code shown)

Track improvement project 4 - North York Street Reserve to Bass Highway (sheet 3 of 3)

LEGEND

-  Title Boundary
-  Existing Inglis River Trail alignment
-  Existing path/structure to be demolished and revegetated/made good
-  Proposed trail alignment
-  Risk zone (sea level rise)
-  Existing trail entrance

Existing path
 Retain existing alignment due to location of existing trees. Raise path, provide culverts and stabilise path edges. Refer to Typical New Path Details. (Potential future boardwalk/bridge required.)

Proposed realignment
 Realign path away from risk zone

Proposed realignment
 Realign path away from risk zone and align path to achieve required grade. Refer to Typical New Path Detail.

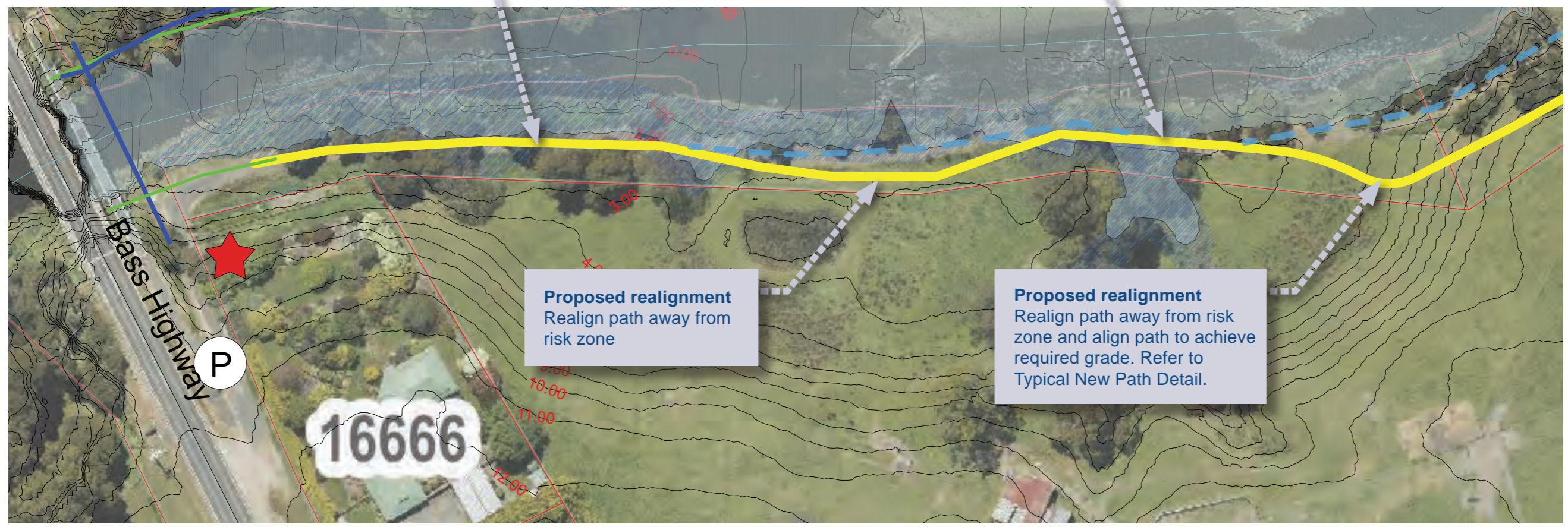

Track improvement project 5 - Golf Links Road (sheet 1 of 1)

SECTION:
(g) Cape Bridge to Fossil Bluff

TYPICAL PROPOSED PATH WIDTH: 2m

NOMINAL PWS PATH CLASSIFICATION:
W2 (Standard nature trail)

NOTES:

- Refer to typical details at the end of this section.
- Construction within protection zones of existing trees to be undertaken using non-invasive techniques. A Tree Protection Plan (if required) to be prepared by a qualified Arborist.
- A Flora and Fauna Report (if required) is to be prepared by a qualified Ecologist.
- Title boundaries and location of any services to be determined prior to construction.
- This drawing is based on GIS data provided by Waratah-Wynyard Council, information obtained from the LIST and site observations, and is intended for general information and planning purposes only. A detailed site survey should be undertaken prior to commencing detailed design.

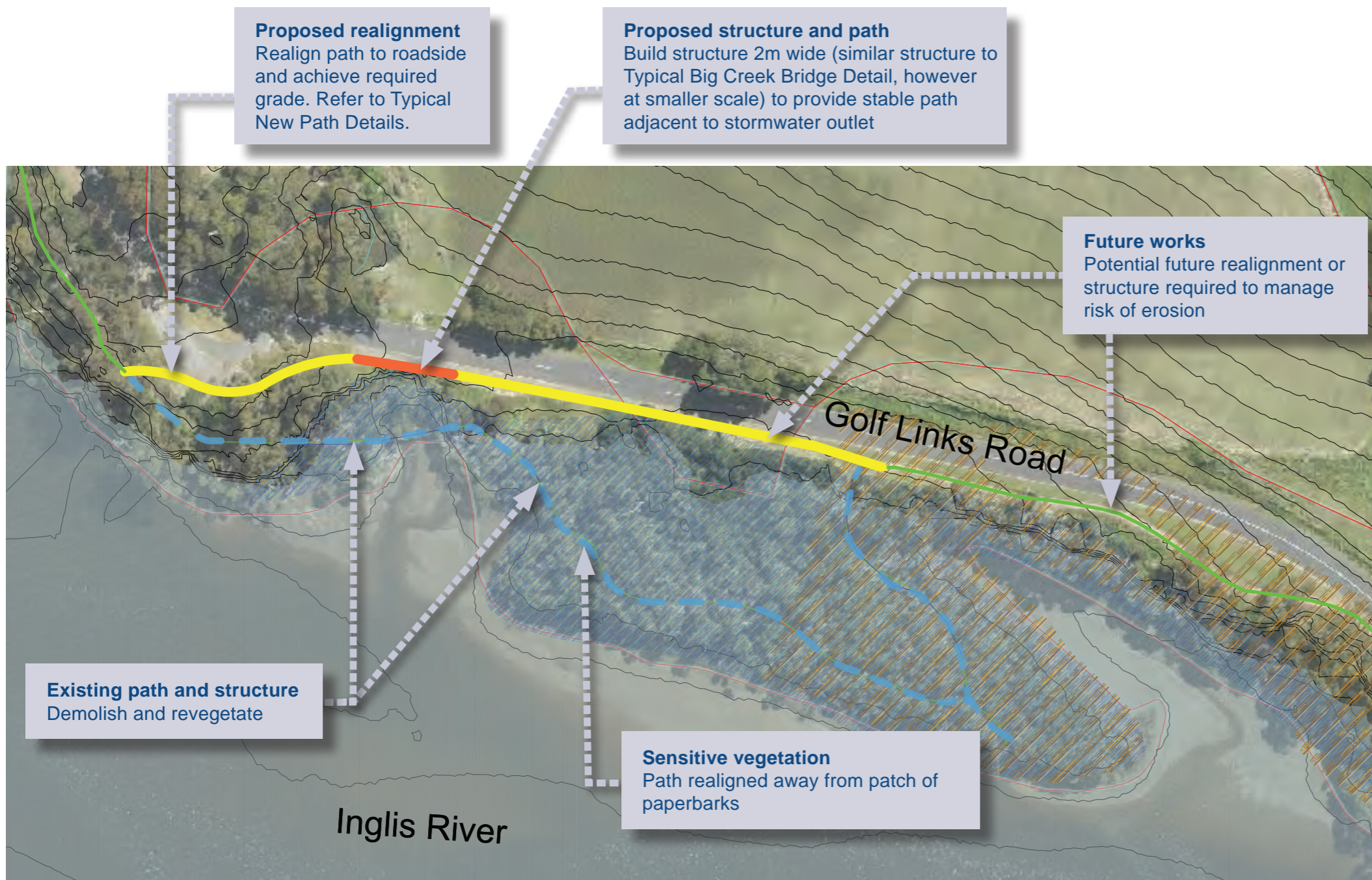

LEGEND

- Title Boundary
- Existing Inglis River Trail alignment
- - Existing path/structure to be demolished and revegetated/made good
- Proposed trail alignment
- Proposed trail structure
- Risk zone (sea level rise)
- ▨ Risk zone (storm tide encroachment)
- ▩ Risk zone (coastal erosion hazard band)

Typical details

Typical details have been prepared by the project engineers (Rare Innovation) based on the requirements of the improvement projects.

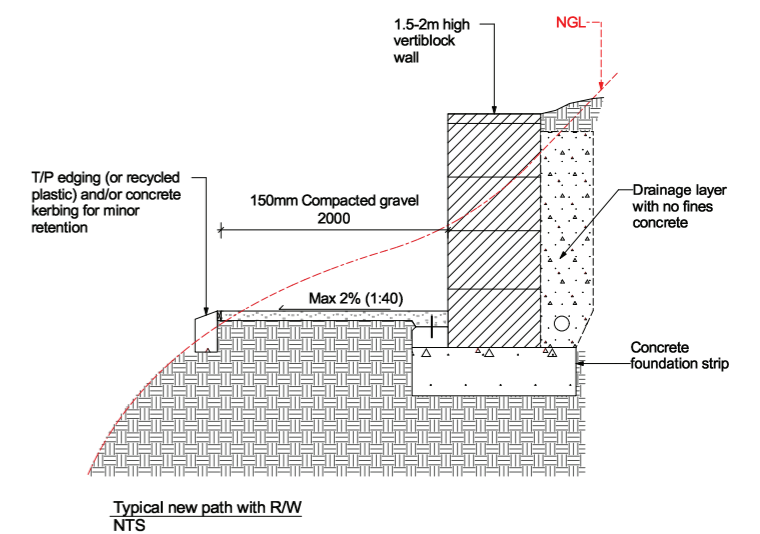
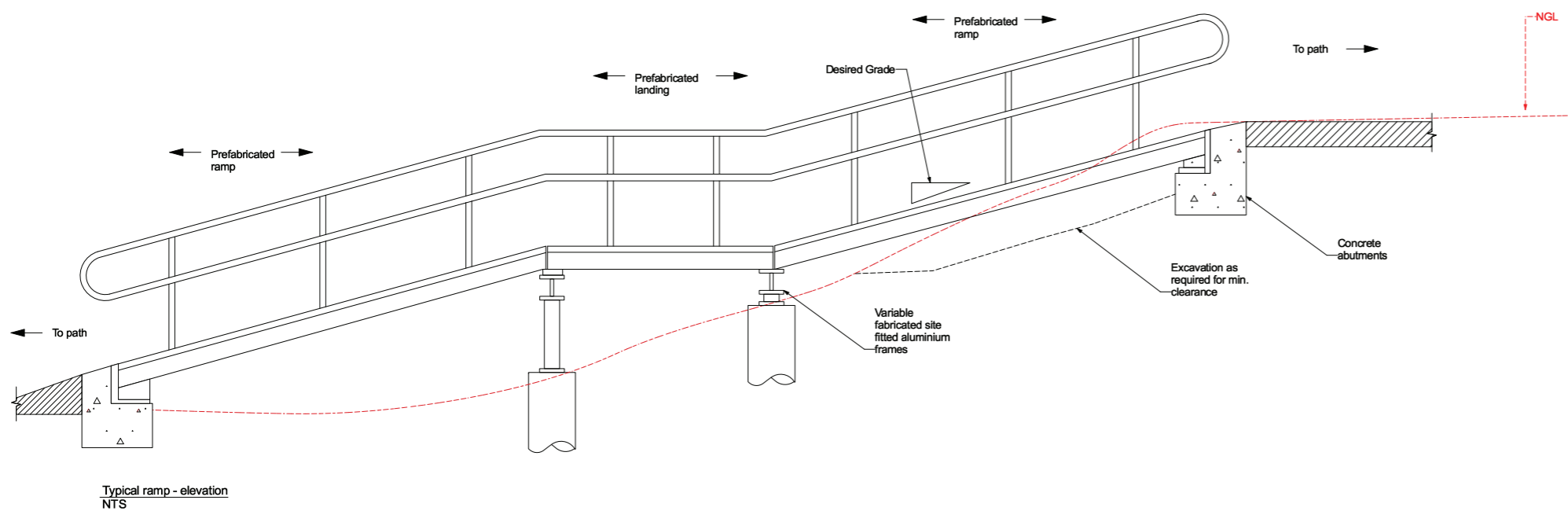
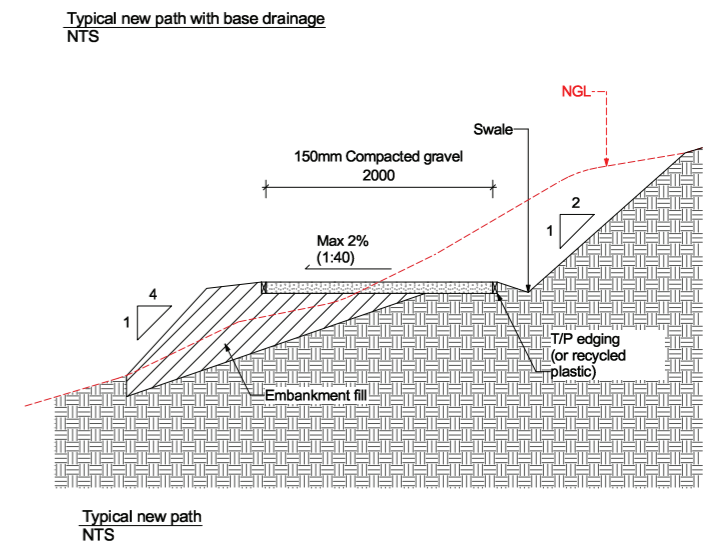
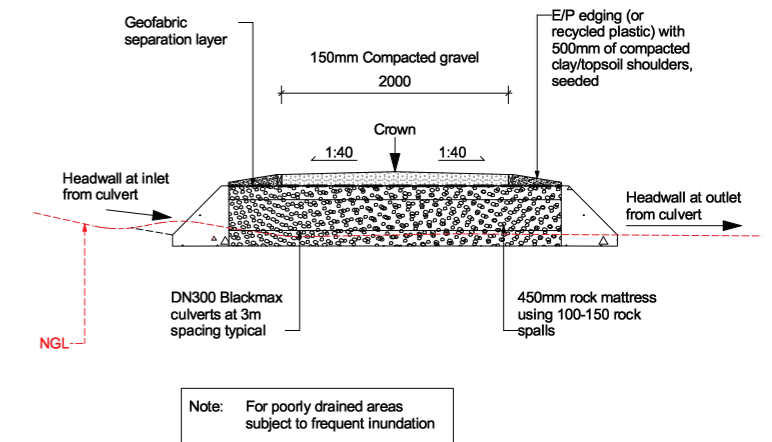
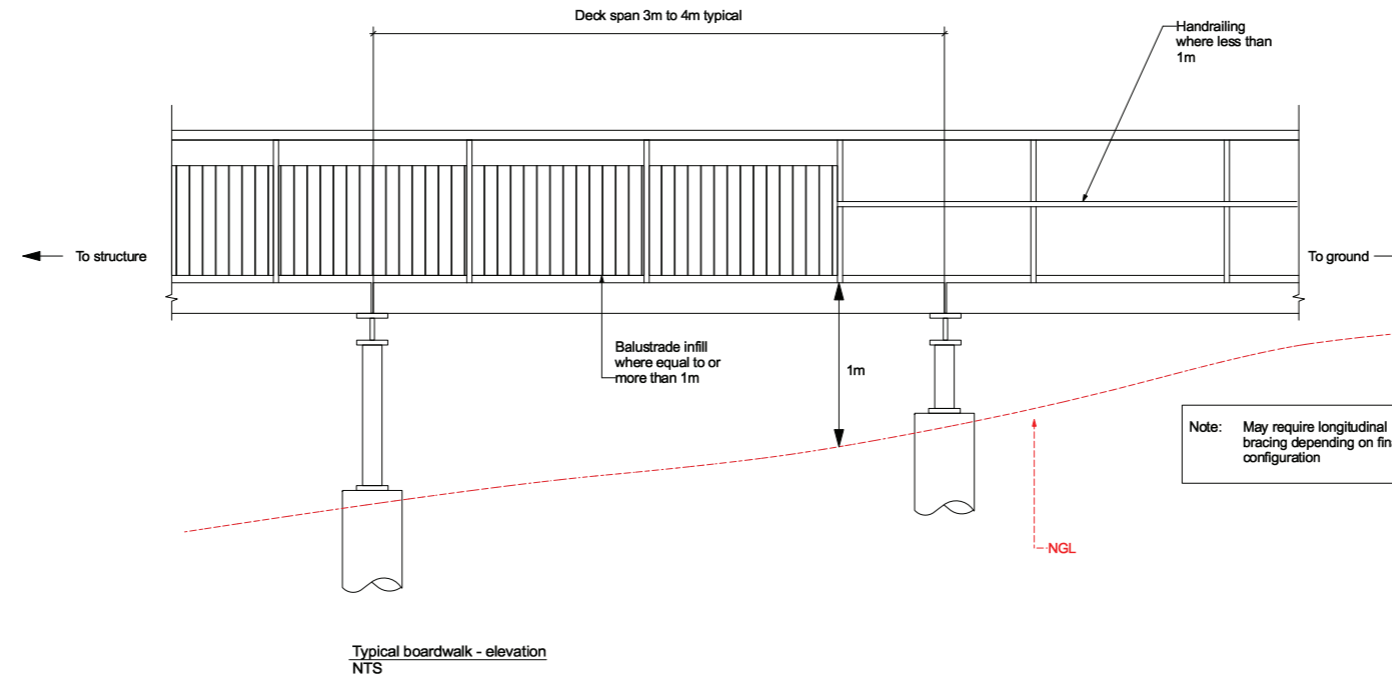
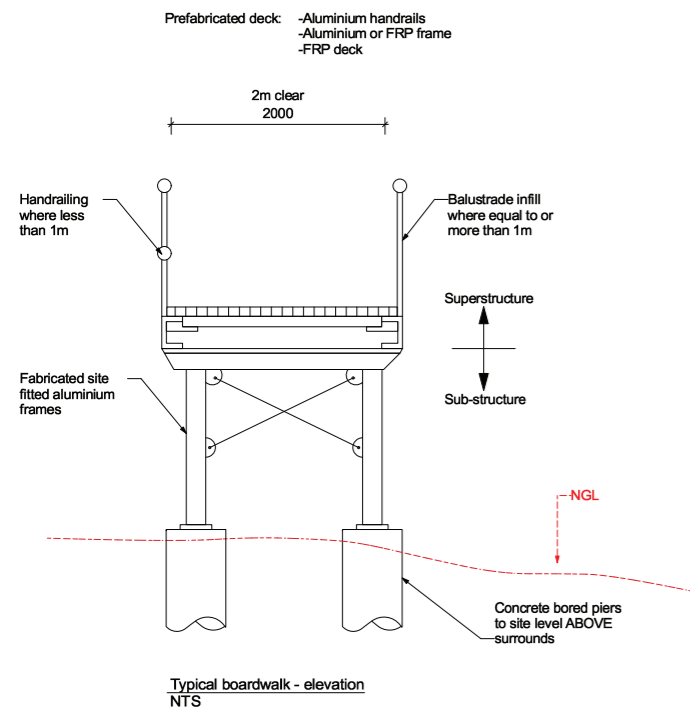

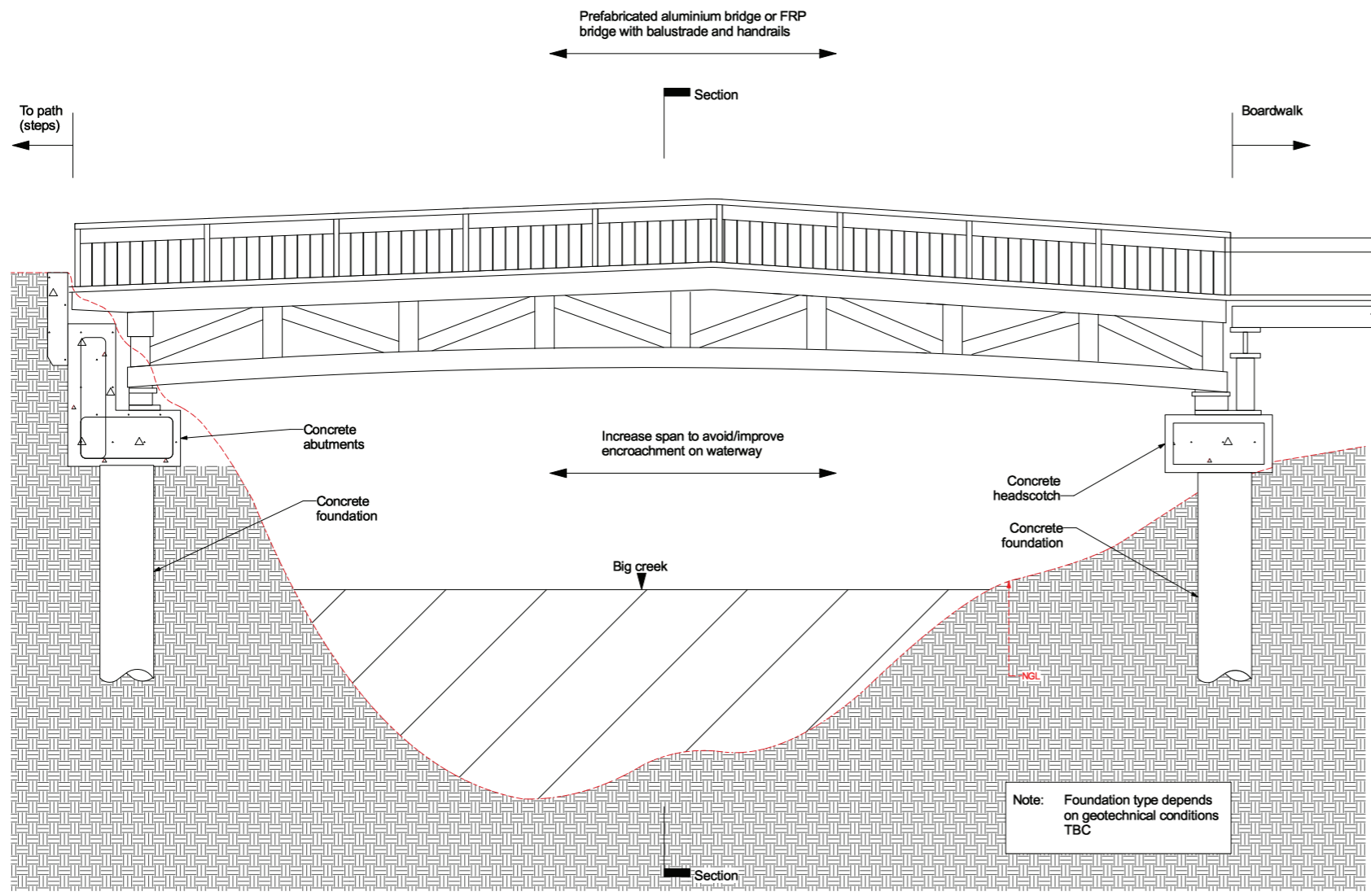

Big creek bridge replacement - elevation
NTS

CONCEPT ONLY

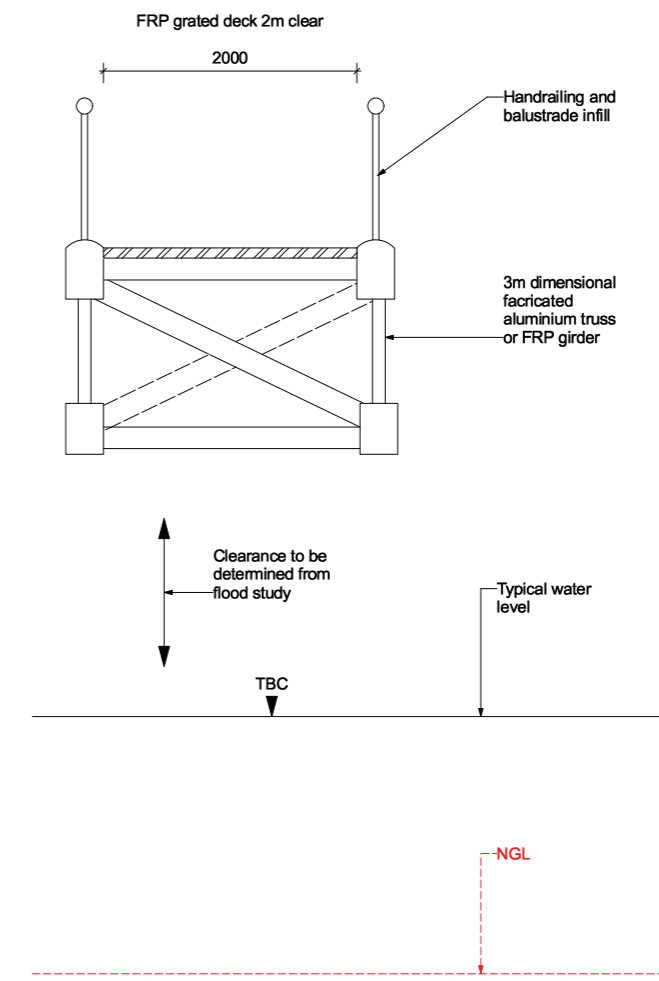

Big creek bridge replacement - Section
NTS

6 Multi-criteria analysis of projects

Criteria and weighting

The criteria developed to assess potential trail improvement projects were designed to assess the five improvement projects against the key objectives of the study. Projects were allocated 'High', 'Medium' and 'Low' rankings for each criterion to determine the score given under each heading.

It should be noted that the assessment method used is intended to provide a useful prioritisation tool but it is not scientific. While the method used does rank projects in order, the accuracy of the method means that it is best used to provide only broad direction regarding relative priorities.

Any risk and safety issues should be considered with reference to a broader risk management approach/strategy and as such have not been included here.

The seven criteria and the relative weighting are as follows:

1. Cost indicator (25%)

Financial cost of the project. Rankings for 'High', 'Medium' and 'Low' costs to be determined based on overall project cost as well as on comparison with alternatives (ie. if cost differences between projects are negligible they may receive the same ranking for this criterion, allowing other criteria to determine the outcome).

Rationale: Structure replacement, upgrade and maintenance of the trail present a significant financial cost. It is important that the financial impacts of projects are given sufficient weight to ensure value for money is achieved.

2. Maintenance obligation (15%)

Employs materials and alignments that are calculated to reduce maintenance requirements. Avoids areas designated as susceptible to erosion and sea-level rise.

Rationale: This criterion ensures that ongoing costs are taken into account in addition to up front capital works costs, as well as improving the reliability of the trail for public use by reducing the need to close the trail for repairs.

3. Accessibility benefit (15%)

Improved accessibility to people with a wider range of abilities, for example through elimination of stairs or improvement of surface stability. Note that the level of accessibility that can be achieved will vary between trail segments due to site constraints.

Rationale: Improving accessibility is desirable for improving the ability of a broader section of the population to use the trail.

4. Character and context (10%)

This criterion addresses the presentation of the trail. The design (including materials) of the proposal is in keeping with the character and context of the surrounding landscape and uses, and the preferred character of the trail itself.

Rationale: The trail runs through an area valued by the community for its bushland character. The trail's character is an important aspect of its appeal.

5. Impact on vegetation (15%)

Impact of construction on remnant, protected native or otherwise significant, vegetation.

Rationale: Adverse impact to vegetation is undesirable from an ecological perspective.

6. Likelihood of increasing use (10%)

Implementation of the project is likely to increase use either by making the trail more appealing or improving the ability of the public to access it, thereby maximising opportunities for the use of the trails for active transport, recreation and social interaction.

Rationale: This criterion assumes that increasing use is a desirable outcome based on likely health and wellbeing benefits to the community (positive contributions the 'social' aspect of a triple bottom line assessment), as well as potential economic benefits to local businesses if visitors are attracted to the area.

7. Impact on Aboriginal heritage (10%)

Impact of construction (if any) on Aboriginal heritage sites, taking into account the advice and recommendations of the Aboriginal Heritage Report. This criterion is to be considered separately to any capital works and maintenance costs associated with following the recommendations of the Report.

Rationale: Adverse impact to Aboriginal heritage sites should be avoided.

Multi-criteria analysis results

Note: For full details of the multi-criteria analysis please refer to the Appendix.

Method

In the first part of the analysis each Improvement Project was broken down into sub-sections based on the type of amendments required, for example construction of a bridge, a gravel path or a retaining wall. Each sub-section was then assessed against each analysis criterion and allocated a value. The sub-sections' values were averaged to achieve a final value for each criterion.

A similar process to the above was undertaken for a 'baseline' option of continuing to maintain existing path alignments and structures as they currently exist in the location of each Improvement Project. This allows projects to be compared against a 'no change' scenario, as well as against each other.

The second part of the analysis weighted the value for each Improvement Project and 'baseline' option criterion according to Council's priorities (as outlined in the 'Criteria and weighting' section).

Finally the weighted values of the criteria were added together to produce a single rating of between 1-100 points for each Improvement Project and 'baseline' option.

Observations

All the proposed Improvement Projects rate higher than the 'baseline' of maintaining those sections of track as they currently exist.

Improvement Project 2 (Esplanade to Cemetery) shows the greatest potential for improvement with a 20 point differential to the base option, however it also starts from a slightly higher baseline.

Ratings are clustered around 51-55 at the baseline and (with the exception of Project 2) 64-67 for the improvements

Big Creek Bridge has the lowest starting point, but Boat Ramp to Picnic Ground and Golf Links Road are rated within a couple of points.

Recommendations

Based on the assessment criteria, the benefits of implementing the improvement projects outweigh the benefits of retaining existing conditions of the track. Therefore, all projects have been considered in further detail in the Implementation section of this report.

Due to the strong clustering of ratings it is recommended that implementation priority be determined with reference to survey results, especially levels of use, except where structural replacements are required. These items are considered in the next section.

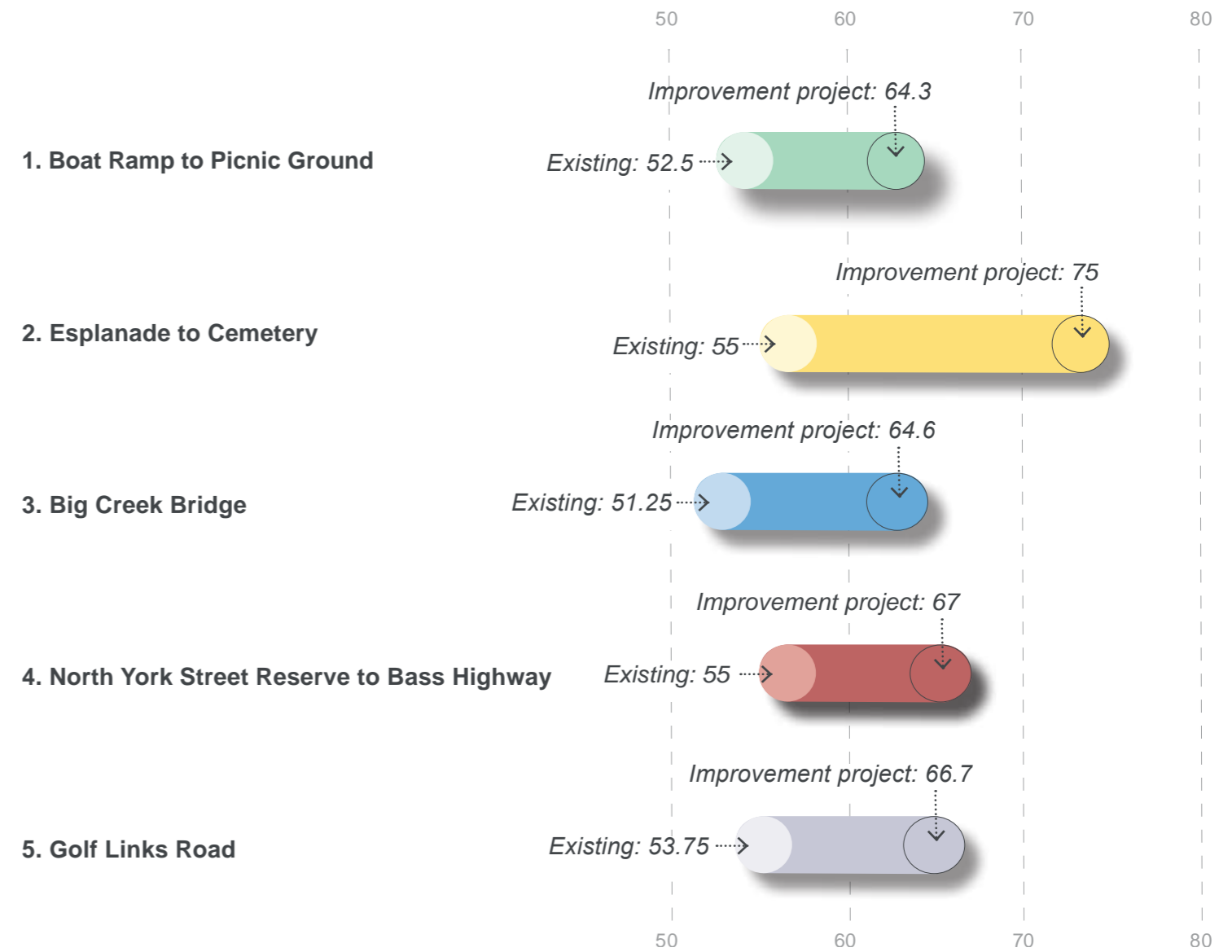

Figure: Summary of multi-criteria analysis of Improvement Projects.
NOTE: For full details of the multi-criteria analysis please refer to the Appendix.

7 Implementation

Indicative costs* and hierarchy

As noted in the previous section implementation priority may be determined with reference to levels of use reported in the survey results. However due to several structures having already reached the end of their design life these projects are prioritised ahead of other improvements for safety reasons. The improvement projects are presented below in hierarchical order.

*This Implementation Plan is a high-level document based on preliminary studies and is intended for planning purposes only. No allowance has been made for escalation.

First priority

Track improvement Project 5 - Golf Links Road

Indicative total cost, ex. GST: \$835,000

Item	Description	Quantity	Unit	Rate	Amount
Project 5 - Golf Links Road (total length approx. 160m)					
5.1	Existing carpark to stream. Realign path to roadside path to achieve desired grades incl. Minor Earthworks, clearing, 2.0m wide x 150 thick gravel path, upslope drainage	50	lin.m	\$ 120.0	\$ 6,000.0
5.2	Stream crossing. Create new bridge over existing stream / inlet. Medium scale aluminium prefabricated structure. Heavy machinery/Craneage. Complex foundations.	1	Item	\$ 500,000.0	\$ 500,000.0
5.3	Existing stream to connection after existing path terminus. Realign path to roadside path to achieve desired grades	90	lin.m	\$ 120.0	\$ 10,800.0
5.4	Demolish existing and revegetate/rehabilitate	280	lin.m	\$ 150.0	\$ 42,000.0
5.5	Rest stop (seat)	1	Item	\$ 3,500.0	\$ 3,500.0
5.6	Access points: Provide track signage (map, including accessibility info), bins and poo bags at access points.	1	Item	\$ 3,000.0	\$ 3,000.0
5.7	Interpretive signage	1	Item	\$ 5,000.0	\$ 5,000.0
5.8	Allowance for additional revegetation/amenity planting	160	Item	\$ 100.0	\$ 16,000.0
Subtotal					\$ 586,300.0
5.9	Preliminaries	10	%	\$ 586,300.0	\$ 58,630.0
Subtotal construction					\$ 644,930.0
5.10	Design contingency	10	%	\$ 644,930.0	\$ 64,493.0
5.11	Construction contingency	10	%	\$ 644,930.0	\$ 64,493.0
5.12	Consultant's fees (allowance)	8	%	\$ 644,930.0	\$ 51,594.4
5.13	Authorities' fees and charges	1	%	\$ 644,930.0	\$ 6,449.3
Total construction					\$ 831,959.7
GST 10%					\$ 83,196.0
Total					\$ 915,155.7

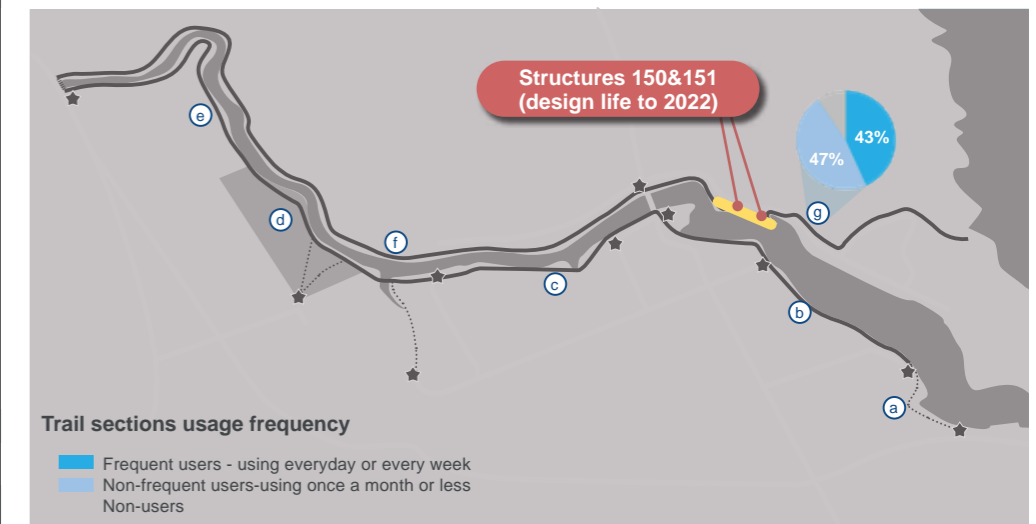

Image: Context plan Improvement Project 5

Second Priority

Track improvement Project 2 - Esplanade to Cemetery

Indicative total cost, ex. GST: \$190,000

Item	Description	Quantity	Unit	Rate	Amount
Project 2 - Esplanade to Cemetery (total length approx. 310m)					
2.1	17 Wynyard Esp to Wynyard Cemetery. Realign path away from steep, eroding edge and reduce encroachment on vegetation. Incl. minor Earthworks, clearing, 2.0m wide x 150 thick gravel path, upslope drainage.	310	Item	\$ 120.0	\$ 37,200.0
2.2	Demolish existing and revegetate/rehabilitate.	335	Item	\$ 150.0	\$ 50,250.0
2.3	Rest stop (seat)	1	Item	\$ 3,500.0	\$ 3,500.0
2.4	Access points: Provide track signage (map, including accessibility info), bins and poo bags at access points.	2	Item	\$ 3,000.0	\$ 6,000.0
2.5	Interpretive signage	1	Item	\$ 5,000.0	\$ 5,000.0
2.6	Allowance for additional amenity planting and revegetation	310	Lin.m	\$ 100.0	\$ 31,000.0
				Subtotal	\$ 132,950.0
2.7	Preliminaries	10	%	\$ 132,950.0	\$ 13,295.0
				Subtotal construction	\$ 146,245.0
2.8	Design contingency	10	%	\$ 146,245.0	\$ 14,624.5
2.9	Construction contingency	10	%	\$ 146,245.0	\$ 14,624.5
2.10	Consultant's fees (allowance)	8	%	\$ 146,245.0	\$ 11,699.6
2.11	Authorities' fees and charges	1	%	\$ 146,245.0	\$ 1,462.5
				Total construction	\$ 188,656.1
				GST 10%	\$ 18,865.6
				Total	\$ 207,521.7

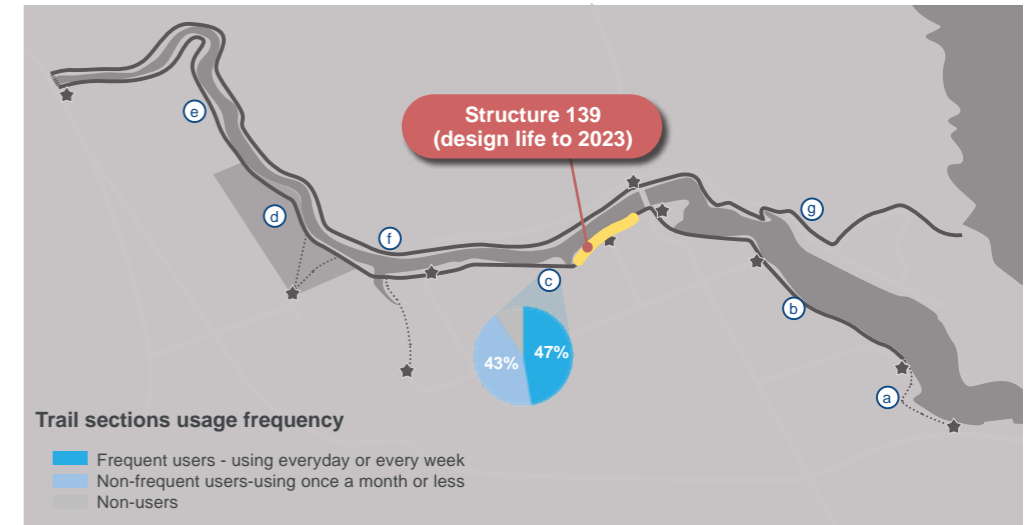

Image: Context plan Improvement Project 2

Third Priority

Track improvement Project 3 - Big Creek Bridge

Indicative total cost, ex. GST: \$965,000

Item	Description	Quantity	Unit	Rate	Amount
Project 3 - Big Creek Bridge (total length approx. 140m)					
3.1	Hayes Street to Bridge Approach. Minor realignment of path away from risk zone incl. minor Earthworks, clearing, 2.0m wide x 150 thick gravel path, upslope drainage, small scale retaining walls.	70	Lin.m	\$ 120.0	\$ 8,400.0
3.2	Bridge Approach. Extend bridge at East bank to deal with erosion/flooding. Earthworks, clearing, concrete foundation works, Small scale aluminium or GRP framed elevated walkway with GRP decking. 2.0m wide Minimal drainage.	45	Lin.m	\$ 600.0	\$ 27,000.0
3.3	Big Creek Bridge. Replace Big Creek Bridge. Large scale aluminium prefabricated structure. Heavy machinery/Craneage. Complex foundations.	1	Item	\$ 600,000.0	\$ 600,000.0
3.4	Demolish existing and revegetate/rehabilitate.	100	Lin.m	\$ 150.0	\$ 15,000.0
3.5	Rest stop (seat)	2	Item	\$ 3,500.0	\$ 7,000.0
3.6	Access points: Provide track signage (map, including accessibility info), bins and poo bags at access points.	1	Item	\$ 3,000.0	\$ 3,000.0
3.7	Interpretive signage	1	Item	\$ 5,000.0	\$ 5,000.0
3.8	Allowance for additional amenity planting and revegetation	140	Lin.m	\$ 100.0	\$ 14,000.0
				Subtotal	\$ 679,400.0
3.9	Preliminaries	10	%	\$ 679,400.0	\$ 67,940.0
				Subtotal construction	\$ 747,340.0
3.10	Design contingency	10	%	\$ 747,340.0	\$ 74,734.0
3.11	Construction contingency	10	%	\$ 747,340.0	\$ 74,734.0
3.12	Consultant's fees (allowance)	8	%	\$ 747,340.0	\$ 59,787.2
3.13	Authorities' fees and charges	1	%	\$ 747,340.0	\$ 7,473.4
				Total construction	\$ 964,068.6
				GST 10%	\$ 96,406.9
				Total	\$ 1,060,475.5

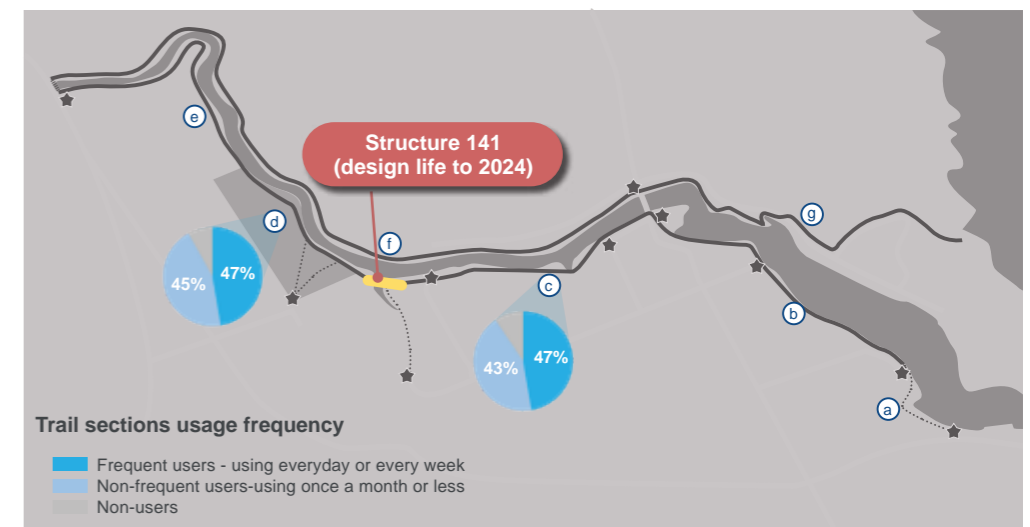

Image: Context plan Improvement Project 3

Fourth Priority

Track improvement Project 1 - Boat Ramp to Picnic Ground

Indicative total cost, ex. GST: \$450,000

Item	Description	Quantity	Unit	Rate		Amount
Project 1 - Boat Ramp to Picnic Ground (total length approx. 1000m)						
1.1	Jenner St. Cut path through mound retaining required (near roadway). Earthworks, clearing, 2.0m wide x 150 thick gravel path, upslope drainage, engineered retaining wall. Approx Length 20m.	20	Lin.m	\$	500.0	\$ 10,000.0
1.2	1 Jenner to 67 Jackson St. Realign the trail to higher ground to reduce steepness, erosion and avoid flood risk. Minor Earthworks, clearing, 2.0m wide x 150 thick gravel path, upslope drainage, small scale retaining walls.	145	Lin.m	\$	120.0	\$ 17,400.0
1.3	67 to 77 Jackson St. Proposed ramp with handrails (nom. Width 2.0m). Earthworks, clearing, concrete foundation works, Small scale aluminium or GRP framed elevated walkway with GRP decking. 2.0m wide Minimal drainage.	40	Lin.m	\$	600.0	\$ 24,000.0
1.4	92 to 96 Jackson St. Propose ramp with handrails (nom. Width 2.0m). Earthworks, clearing, concrete foundation works, Small scale aluminium or GRP framed elevated walkway with GRP decking. 2.0m wide Minimal drainage.	40	Lin.m	\$	600.0	\$ 24,000.0
1.5	Gibbons St Cul-de-sac. Realignment of path around Cul-de-sac. Minor Earthworks, clearing, 2.0m wide x 150 thick gravel path, minimal drainage.	20	Lin.m	\$	120.0	\$ 2,400.0
1.6	3 Gibbons St to 101 Saunders St. Realign path away from steep edge and reduce encroachment on vegetation. Moderate Earthworks, clearing, 2.0m wide x 150 thick gravel path, upslope drainage.	190	Lin.m	\$	120.0	\$ 22,800.0
1.7	Picnic Grounds Saunders Street. Realign path way from risk zone. Connect to existing path through trees. Minor Earthworks, clearing, 2.0m wide x 150 thick gravel path, upslope drainage, small scale retaining walls.	55	Lin.m	\$	120.0	\$ 6,600.0
1.8	Provide balustrade and make good to replace lost manhole and embankment zone	1	Item	\$	3,000.0	\$ 3,000.0
1.9	Demolish existing and revegetate/rehabilitate.	580	Lin.m	\$	150.0	\$ 87,000.0
1.10	Rest stop (seat)	2	Item	\$	3,500.0	\$ 7,000.0
1.11	Access points: Provide track signage (map, including accessibility info), bins and poo bags at access points.	3	Item	\$	3,000.0	\$ 9,000.0
1.12	Interpretive signage	1	Item	\$	5,000.0	\$ 5,000.0
1.13	Allowance for additional amenity planting and revegetation	1000	Lin.m	\$	100.0	\$ 100,000.0
1.14	Allowance for privacy screening adjacent to properties (planting or fencing).	145	Lin.m	\$	150.0	\$ 21,750.0
				Subtotal	\$	318,200.0
1.15	Preliminaries	10	%	\$	318,200.0	\$ 31,820.0
				Subtotal construction	\$	350,020.0
1.16	Design contingency	10	%	\$	350,020.0	\$ 35,002.0
1.17	Construction contingency	10	%	\$	350,020.0	\$ 35,002.0
1.18	Consultant's fees (allowance)	8	%	\$	350,020.0	\$ 28,001.6
1.19	Authorities' fees and charges	1	%	\$	350,020.0	\$ 3,500.2
				Total construction	\$	451,525.8
				GST 10%	\$	45,152.6
				Total	\$	496,678.4

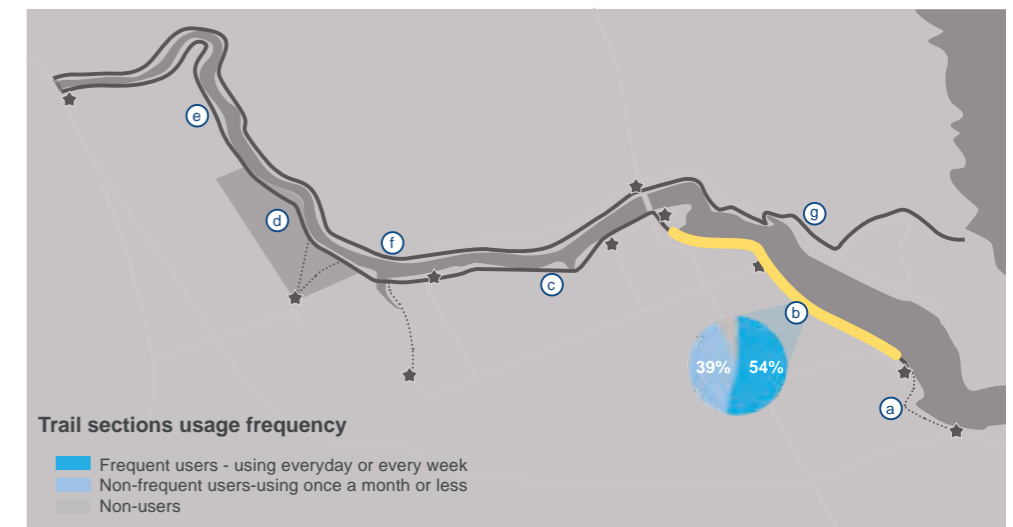

Image: Context plan Improvement Project 1

Fifth Priority

Track improvement Project 4 - North York Street Reserve to Bass Highway

Indicative total cost, ex. GST: \$700,000

Item	Description	Quantity	Unit	Rate		Amount
Project 4 - Upgrade South Bank, Link to Hwy (total length approx. 1,115m)						
4.1	16628 Bass Hwy to existing dam. Realign path to achieve desired grades, incl. Minor to Moderate Earthworks, clearing, 2.0m wide x 150 thick gravel path, upslope drainage.	185	lin.m	\$ 150.0		\$ 27,750.0
4.2	Adjacent existing dam. Construct boardwalk structure over inlet (pedestrian only). Earthworks, clearing, concrete foundation works, Small scale aluminium or GRP framed elevated walkway with GRP decking. 2.0m wide Minimal drainage.	45	lin.m	\$ 600.0		\$ 27,000.0
4.3	Dam to end of river bend. Realign path to achieve desired grades and to keep away from risk zone. Minor Earthworks, clearing, 2.0m wide x 150 thick gravel path, upslope drainage.	670	lin.m	\$ 120.0		\$ 80,400.0
4.4	End of river bend to Farm Creek. Raise level of path, provide culverts and stabilise edges. Minor to Moderate Earthworks, clearing, 2.0m wide x 150 thick gravel path, culverts and drainage mattress/ ballasted base.	35	lin.m	\$ 200.0		\$ 7,000.0
4.5	Farm Creek to Hwy. Realign path away from risk zone incl. Minor Earthworks, clearing, 2.0m wide x 150 thick gravel path, upslope drainage.	180	lin.m	\$ 120.0		\$ 21,600.0
4.6	Demolish existing and revegetate/rehabilitate	1115	lin.m	\$ 150.0		\$ 167,250.0
4.7	Rest stop (seat)	3	Item	\$ 3,500.0		\$ 10,500.0
4.8	Access points: Provide track signage (map, including accessibility info), bins and poo bags at access points.	1	Item	\$ 3,000.0		\$ 3,000.0
4.9	Interpretive signage	2	Item	\$ 5,000.0		\$ 10,000.0
4.10	Allowance for additional amenity planting and revegetation	1115	lin.m	\$ 100.0		\$ 111,500.0
4.11	Allowance for privacy screening adjacent to properties (planting or fencing).	165	Lin.m	\$ 150.0		\$ 24,750.0
				Subtotal		\$ 490,750.0
4.12	Preliminaries	10	%	\$ 490,750.0		\$ 49,075.0
				Subtotal construction		\$ 539,825.0
4.13	Design contingency	10	%	\$ 539,825.0		\$ 53,982.5
4.14	Construction contingency	10	%	\$ 539,825.0		\$ 53,982.5
4.15	Consultant's fees (allowance)	8	%	\$ 539,825.0		\$ 43,186.0
4.16	Authorities' fees and charges	1	%	\$ 539,825.0		\$ 5,398.3
				Total construction		\$ 696,374.3
				GST 10%		\$ 69,637.4
				Total		\$ 766,011.7

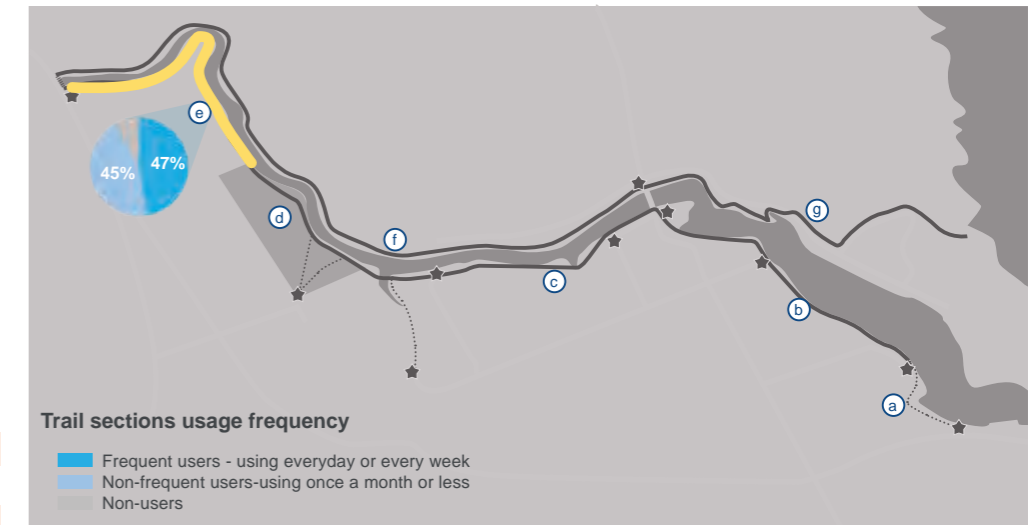

Image: Context plan Improvement Project 4

General recommendations

The following general design recommendations are made for the Track as a whole and an allowance has been made in the improvement project implementation costings.

Track design recommendations

- Access points: provide wayfinding signage (including map and accessibility info), bins and poo bags.
- Seating at min. 400m spacing.
- Provide interpretive signage.
- Move path off steep/erosion-prone and low/flood-prone points if possible. Where this is not possible, structures are required to facilitate access.

The following recommendations are not part of the improvement projects and have therefore not been included in implementation costings.

Signage strategy

Preparation of an integrated wayfinding and interpretive signage strategy to guide the materials, form, style and content of signage across the entirety of the Inglis River Walking Track would improve user experience and safety, and may increase use of the Track among both locals and tourists.

It is recommended that the local Aboriginal community is offered the opportunity to provide direction on the interpretive signage component of the strategy. Local Aboriginal artist/s may also be engaged to prepare artwork for the signage. Note that the process of consultation and engagement will need to be programmed into the project in a way that suits community members, therefore discussions with nominated community members regarding timeframes and fees should begin at the project planning stage.



Image: Signage in York Street Reserve



Image: Pedestrian crossing point at Cape Bridge/Table Cape Road

Management

- Work with Landcare group to prepare a Management Plan (to include a detailed vegetation assessment).
- Support residents to create a Friends group.
- Increase maintenance of high-use areas (note that useage levels may change with investment and will require monitoring).
- Consider implementation of a public awareness campaigns for residents living adjacent to the river corridor about garden escapee weeds.
- Consider creation of recommendations/guidelines for pet owners living adjacent to the river corridor.

Pedestrian safety

improve pedestrian safety at crossing points on north and south sides of Cape Bridge, for example by introducing traffic calming measures and reducing crossing distance.

Major destination point upgrades

Upgrade Fossil Bluff and Cape Bridge Picnic Ground to create major destination points.

Fossil Bluff

Enhance Fossil Bluff as a destination point.

- Potential infrastructure improvements include upgraded furniture, drinking water, shelter, bins, path connections.
- Implement southern approach path to lookout to avoid passing through suburban area.
- Consider installation of BBQ and toilet (daylight operation only).

Cape Bridge Picnic Ground

Improve facilities at Cape Bridge Picnic Ground to create a highly accessible destination point for trail users coming from Gutteridge Gardens. Note that infrastructure locations will need to take into account potential for flooding.

- Reconfigure car park and turnaround to increase parkland area.
- Additional and upgraded picnic facilities and furniture (BBQ, shelter, drinking fountain, tables, seating).
- Provide public toilet.
- Improve path connections.

Named walks

Advertise recommended walks and provide details of difficulty level, eg.:

'Two Bridges Loop'

- Cape Bridge Picnic Ground to Bass Bridge return along north and south bank.
- Approx. 6km loop
- Bushwalking track (surface may be steep, muddy and/or uneven in places)

'Fossil Bluff Return'

- Cape Bridge Picnic Ground to Fossil Bluff
- Approx. 3.5km round trip
- Standard nature trail (firm track, may include steps and/or steep sections)

'Cape Bridge Return'

- Gutteridge Gardens to Cape Bridge Picnic Ground
- Approx. 3km round trip
- Wheelchair standard nature trail (no steps, firm ground, min. width 1.5m or passing bays provided.)